



# TSW100

v1.14



## HARDWARE

### FRONT VIEW

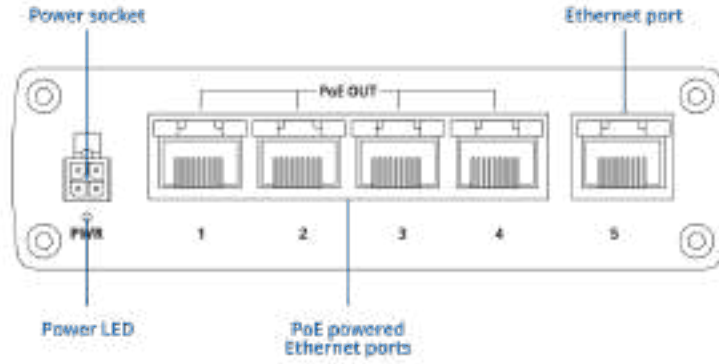

### BACK VIEW

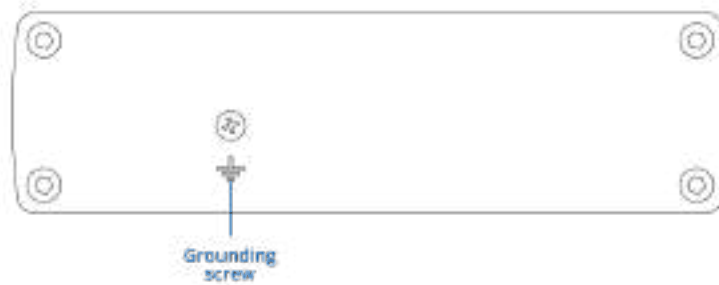

### RJ45 LED MEANING



### POWER SOCKET PINOUT

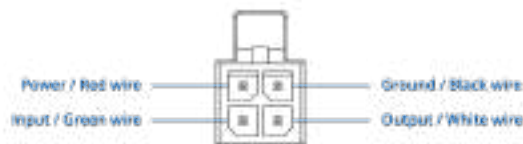

## FEATURES

### Ethernet

<b>ETH</b>	5 x ETH ports, 10/100/1000 Mbps, supports auto MDI/MDIX crossover
<b>IEEE 802.3 series standards</b>	802.3i, 802.3u, 802.3ab, 802.3x, 802.3az

### INDUSTRIAL PROTOCOLS

<b>Profinet</b>	Profinet Class A conformance (available with optional order code)
-----------------	---

### POE OUT

<b>PoE+ ports</b>	Port 1 - 4
<b>PoE standards</b>	IEEE 802.3af (PoE, Type 1) and IEEE 802.3at (PoE+, Type 2), Alternative A (Order code: TSW100 *1****) IEEE 802.3af (PoE, Type 1) and IEEE 802.3at (PoE+, Type 2), Alternative B (Order code: TSW100 *0****)
<b>PoE Max Power per Port (at PSE)</b>	30 W
<b>PoE Power Budget (at PSE)</b>	120 W

### Performance Specifications

<b>Bandwidth (Non-blocking)</b>	10 Gbps
<b>Packer buffer</b>	128 KB
<b>MAC address table size</b>	2K entries
<b>Jumbo frame support</b>	9216 bytes

### Power

<b>Connector</b>	4-pin industrial DC power socket
<b>Input voltage range</b>	7 – 57 VDC
<b>PoE-Out input voltage range</b>	44 – 57 VDC
<b>Power consumption</b>	Idle: 2 W / Max (no PoE): 9 W / PoE Max: 129 W

**Physical Interfaces**

<b>Ethernet</b>	5 x RJ45 ports, 10/100/1000 Mbps
<b>Status LEDs</b>	1 x Power LED, 10 x ETH status LEDs
<b>Power</b>	1 x 4-pin power connector
<b>Other</b>	1 x Grounding screw

**Physical Specification**

<b>Casing material</b>	Full aluminum housing
<b>Dimensions (W x H x D)</b>	115 x 32.2 x 101.2 mm
<b>Weight</b>	350 g
<b>Mounting options</b>	DIN rail, wall mount, flat surface (all require additional kit)

**Operating Environment**

<b>Operating temperature</b>	-40 °C to 75 °C
<b>Operating humidity</b>	5% to 95% non-condensing
<b>Ingress Protection Rating</b>	IP30

**Regulatory & Type Approvals**

<b>Regulatory</b>	CE, UKCA, EAC, UCRF, CITC, ANRT, FCC, IC, NOM, Anatel, CB, E-mark
-------------------	---

**EMC Emissions & Immunity**

<b>Standards</b>	EN 55032:2015 EN 55035:2017 EN 301 489-1 V2.2.3
<b>ESD</b>	EN 61000-4-2:2009
<b>Radiated Immunity</b>	EN IEC 61000-4-3:2006 + A1:2008 + A2:2010
<b>EFT</b>	EN 61000-4-4:2012
<b>Surge Immunity (AC Mains Power Port)</b>	EN 61000-4-5:2014
<b>CS</b>	EN 61000-4-6:2014
<b>DIP</b>	EN 61000-4-11:2004

**Safety**

---

**Standards**

IEC 62368-1:2018

EN IEC 62368-1:2020+A11:2020

**ORDERING**

**STANDARD PACKAGE\***



- [62 W PSU](#)
- TSW100
- QSG (Quick Start Guide)
- Packaging box

\*Standard package contents may differ based on standard order codes.

For more information on all available packaging options – please [contact us](#) directly.

**CLASSIFICATION CODES**

**HS Code:** 851762

**HTS:** 8517.62.00

**AVAILABLE VERSIONS**

TSW100 *1****	N/A	TSW100010000 / Standard package with EU PSU TSW100010010 / Standard package with US PSU TSW100010020 / Standard package with AU PSU TSW100010030 / Standard package with UK PSU TSW1000100A0 / Standard package with Power cable with 4-way screw terminal TSW1000100B0 / Mass packing code TSW100010050 / Without PSU
TSW100 *****1 Profinet Class A conformance	N/A	TSW100010001 / Standard package with EU PSU TSW1000100F1 / Mass packing code

**TSW100 SPATIAL MEASUREMENTS**

**PHYSICAL SPECIFICATION**

**Device housing (W x H x D)\*** 115 x 32.2 x 101.2 mm

**Box (W x H x D):** 175 x 35 x 150 mm

\*Housing measurements are presented without antenna connectors and screws; for measurements of other device elements look to the sections below.

**TOP VIEW**

The figure below depicts the measurements of device and its components as seen from the top:

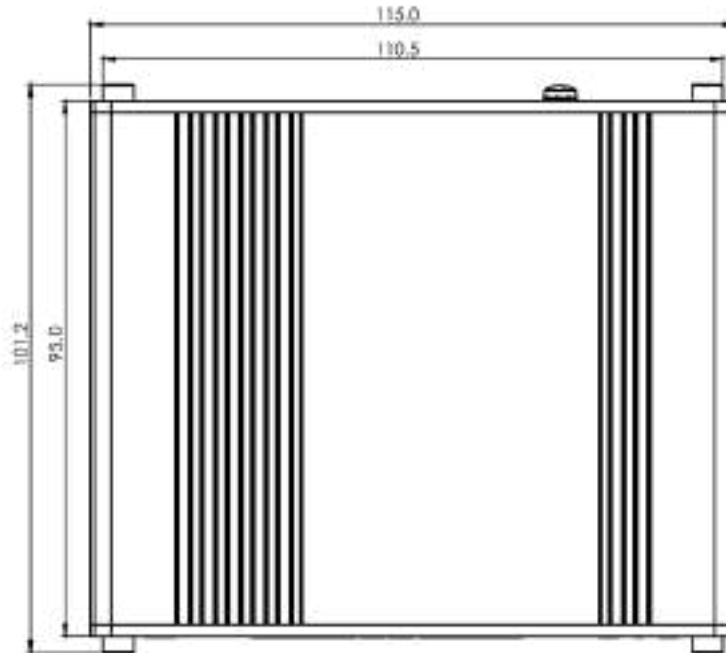

**RIGHT VIEW**

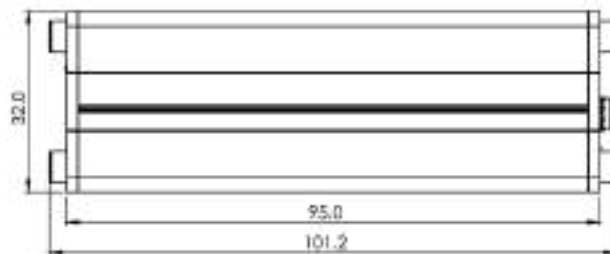
The figure below depicts the measurements of device and its components as seen from the right:

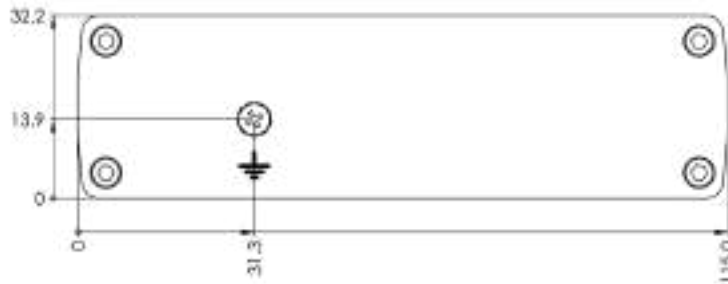

**REAR VIEW**

The figure below depicts the measurements of device and its components as seen from the back panel side:



**FRONT VIEW**

The figure below depicts the measurements of device and its components as seen from the front panel side:

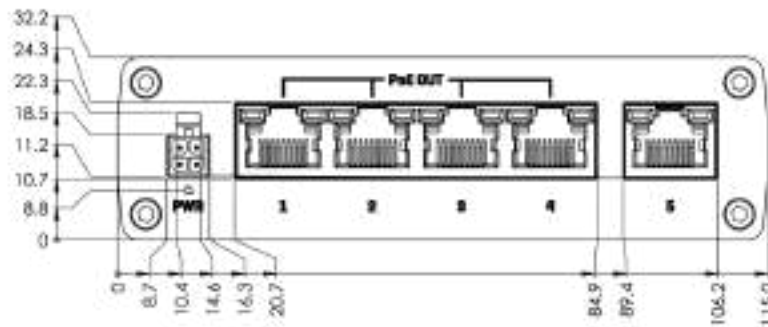

**MOUNTING SPACE REQUIREMENTS**

The figure below depicts an approximation of the device's dimensions when cables and antennas are attached:

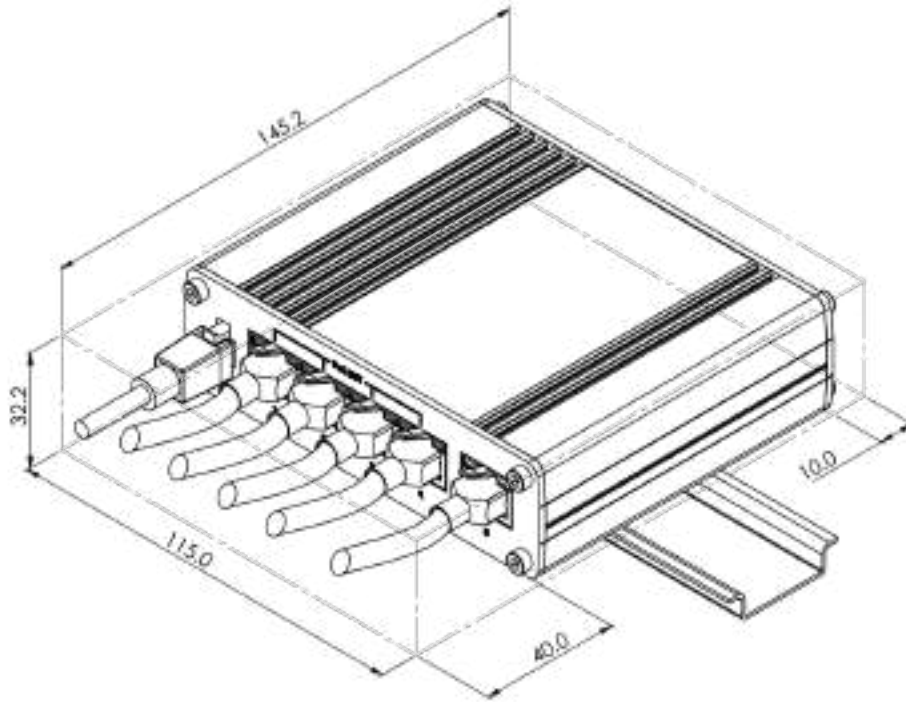
**DIN RAIL**

The scheme below depicts protrusion measurements of an attached DIN Rail:

