

User Manual

Revision 1.000
English

PROFINET / Serial - Converter

(Order Code: HD674-A022)

For Website information:

www.adfweb.com?Product=HD674-A022

For Price information:

www.adfweb.com?Price=HD674-A022

Benefits and Main Features:

- ⊕ Wide supply input range
- ⊕ Electrical isolation
- ⊕ Industrial temperature range: -40°C / 105°C (-40°F / 221°F)



User Manual

For other PROFINET products see also the following link:

Converter PROFINET to

www.adfweb.com?Product=HD67078
www.adfweb.com?Product=HD67090
www.adfweb.com?Product=HD67178
www.adfweb.com?Product=HD67600
www.adfweb.com?Product=HD67601
www.adfweb.com?Product=HD67602
www.adfweb.com?Product=HD67603
www.adfweb.com?Product=HD67604
www.adfweb.com?Product=HD67605
www.adfweb.com?Product=HD67606
www.adfweb.com?Product=HD67607
www.adfweb.com?Product=HD67608
www.adfweb.com?Product=HD67609
www.adfweb.com?Product=HD67610
www.adfweb.com?Product=HD67612
www.adfweb.com?Product=HD67613
www.adfweb.com?Product=HD67614
www.adfweb.com?Product=HD67615
www.adfweb.com?Product=HD67633
www.adfweb.com?Product=HD67659
www.adfweb.com?Product=HD67660
www.adfweb.com?Product=HD67661
www.adfweb.com?Product=HD67679
www.adfweb.com?Product=HD67719
www.adfweb.com?Product=HD67752
www.adfweb.com?Product=HD67778
www.adfweb.com?Product=HD67818
www.adfweb.com?Product=HD67848
www.adfweb.com?Product=HD67876
www.adfweb.com?Product=HD67912
www.adfweb.com?Product=HD67952
www.adfweb.com?Product=HD67984
www.adfweb.com?Product=HD67B22
www.adfweb.com?Product=HD67B46
www.adfweb.com?Product=HD67C77
www.adfweb.com?Product=HD67D33
www.adfweb.com?Product=HD67E23
www.adfweb.com?Product=HD67E73
www.adfweb.com?Product=HD67F33

(M-bus)
(M-bus Wireless)
(SNMP Manager)
(NMEA 2000)
(Serial)
(Modbus Master)
(Modbus Slave)
(PROFIBUS Master)
(PROFIBUS Slave)
(CAN)
(CANopen)
(DeviceNet Master)
(DeviceNet Slave)
(J1939)
(Modbus TCP Slave)
(SNMP Agent)
(DMX)
(NMEA 0183)
(S7comm)
(EtherNet)
(EtherNet/IP Slave)
(EtherNet/IP Master)
(BACnet Slave)
(BACnet Master)
(IEC 61850 Server)
(IEC 61850 Client)
(KNX)
(DALI)
(IO-Link Master)
(HART)
(MQTT)
(IO-Link Slave)
(OPC UA Client)
(OPC UA Server)
(EnOcean)
(LoRaWAN)
(EtherCAT Slave)
(EtherCAT Master)
(LoRaWAN Gateway)

INDEX:

	Page
INDEX	2
UPDATED DOCUMENTATION	2
REVISION LIST	2
WARNING	2
TRADEMARKS	2
SECURITY ALERT	3
EXAMPLE OF CONNECTION	4
CONNECTION SCHEME	5
CHARACTERISTICS	9
CONFIGURATION	9
POWER SUPPLY	10
FUNCTION MODES	11
LEDS	12
RS232	13
RS485	14
ETHERNET	15
USB	15
USE OF COMPOSITOR SW674-A022	16
NEW CONFIGURATION / OPEN CONFIGURATION	17
SOFTWARE OPTIONS	18
SET COMMUNICATION	18
XML FILE	19
UPDATE DEVICE	20
SERIAL PROTOCOL	22
MECHANICAL DIMENSIONS	24
ORDERING INFORMATIONS	28
ACCESSORIES	29
PLC CONFIGURATION	30
DISCLAIMER	33
OTHER REGULATIONS AND STANDARDS	33
WARRANTIES AND TECHNICAL SUPPORT	34
RETURN POLICY	34

UPDATED DOCUMENTATION:

Dear customer, we thank you for your attention and we remind you that you need to check that the following document is:

- ✚ Updated
- ✚ Related to the product you own

To obtain the most recently updated document, note the “document code” that appears at the top right-hand corner of each page of this document.

With this “Document Code” go to web page www.adfweb.com/download/ and search for the corresponding code on the page. Click on the proper “Document Code” and download the updates.

REVISION LIST:

Revision	Date	Author	Chapter	Description
1.000	22/05/2024	Ln	All	Revision

WARNING:

ADFweb.com reserves the right to change information in this manual about our product without warning. ADFweb.com is not responsible for any error this manual may contain.

TRADEMARKS:

All trademarks mentioned in this document belong to their respective owners.

SECURITY ALERT:**GENERAL INFORMATION**

To ensure safe operation, the device must be operated according to the instructions in the manual. When using the device, legal and safety regulation are required for each individual application. The same applies also when using accessories.

INTENDED USE

Machines and systems must be designed so the faulty conditions do not lead to a dangerous situation for the operator (i.e. independent limit switches, mechanical interlocks, etc.).

QUALIFIED PERSONNEL

The device can be used only by qualified personnel, strictly in accordance with the specifications.

Qualified personnel are persons who are familiar with the installation, assembly, commissioning and operation of this equipment and who have appropriate qualifications for their job.

RESIDUAL RISKS

The device is state-of-the-art and is safe. The instruments can represent a potential hazard if they are inappropriately installed and operated by untrained personnel. These instructions refer to residual risks with the following symbol:



This symbol indicates that non-observance of the safety instructions is a danger for people that could lead to serious injury or death and / or the possibility of damage.

CE CONFORMITY

The declaration is made by our company. You can send an email to support@adfweb.com or give us a call if you need it.

EXAMPLE OF CONNECTION:

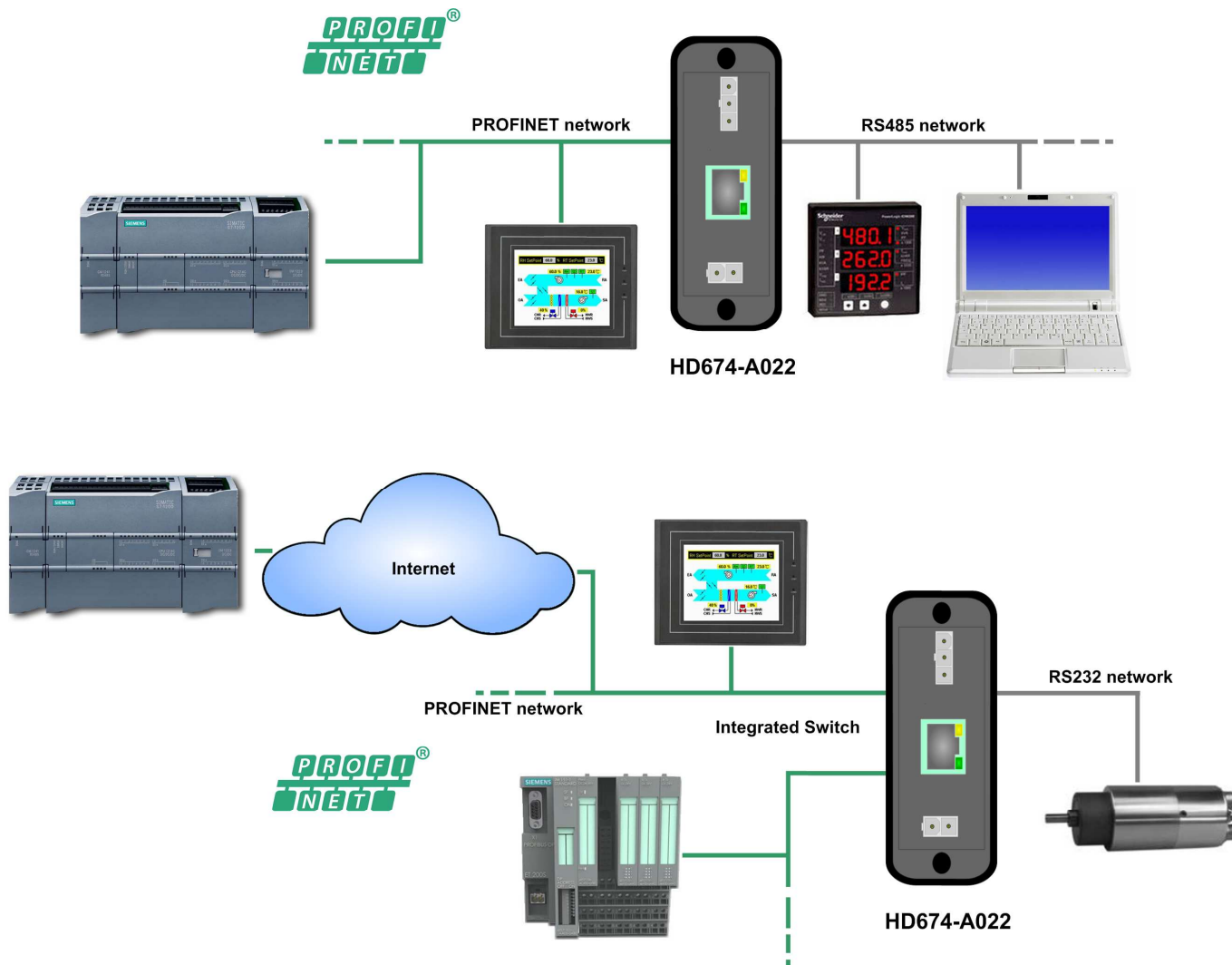

CONNECTION SCHEME:

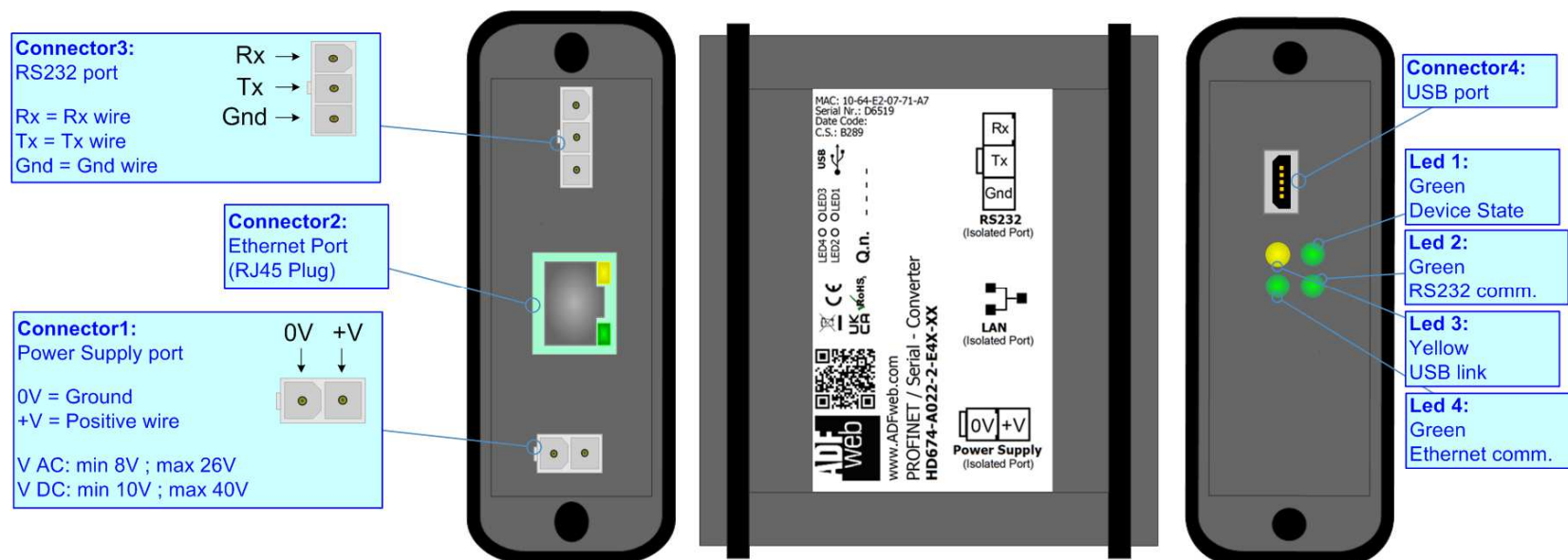

Figure 1a: Connection scheme for HD674-A022-2-E4x

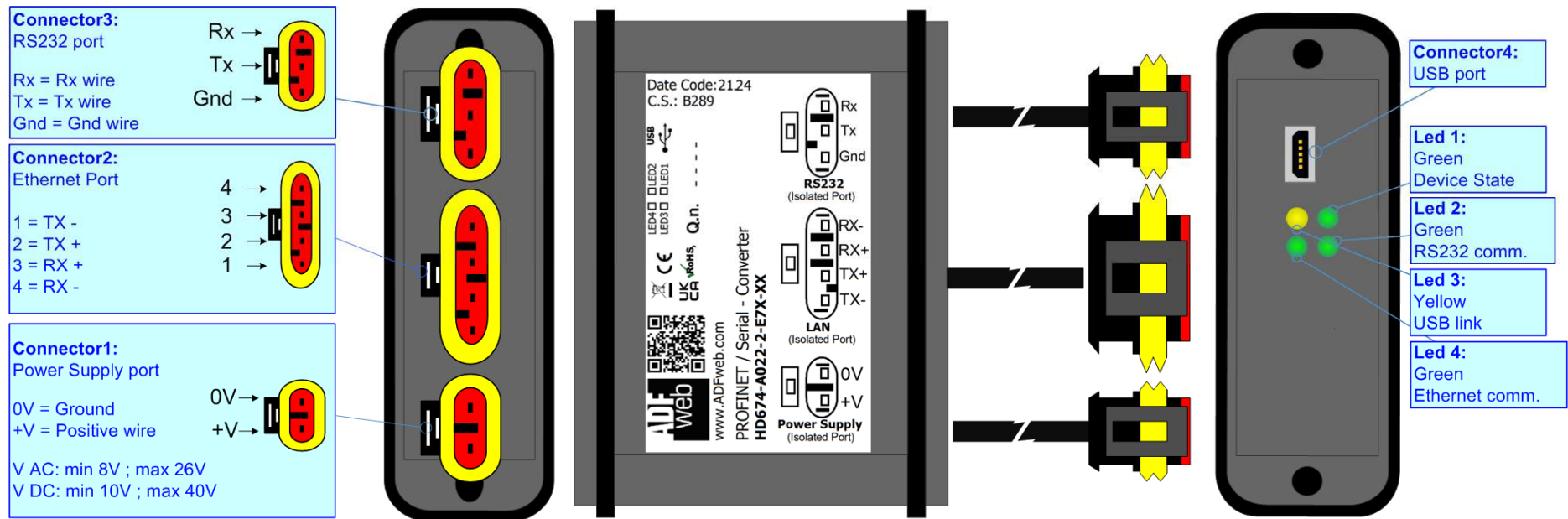

Figure 1b: Connection scheme for HD674-A022-2-E7x

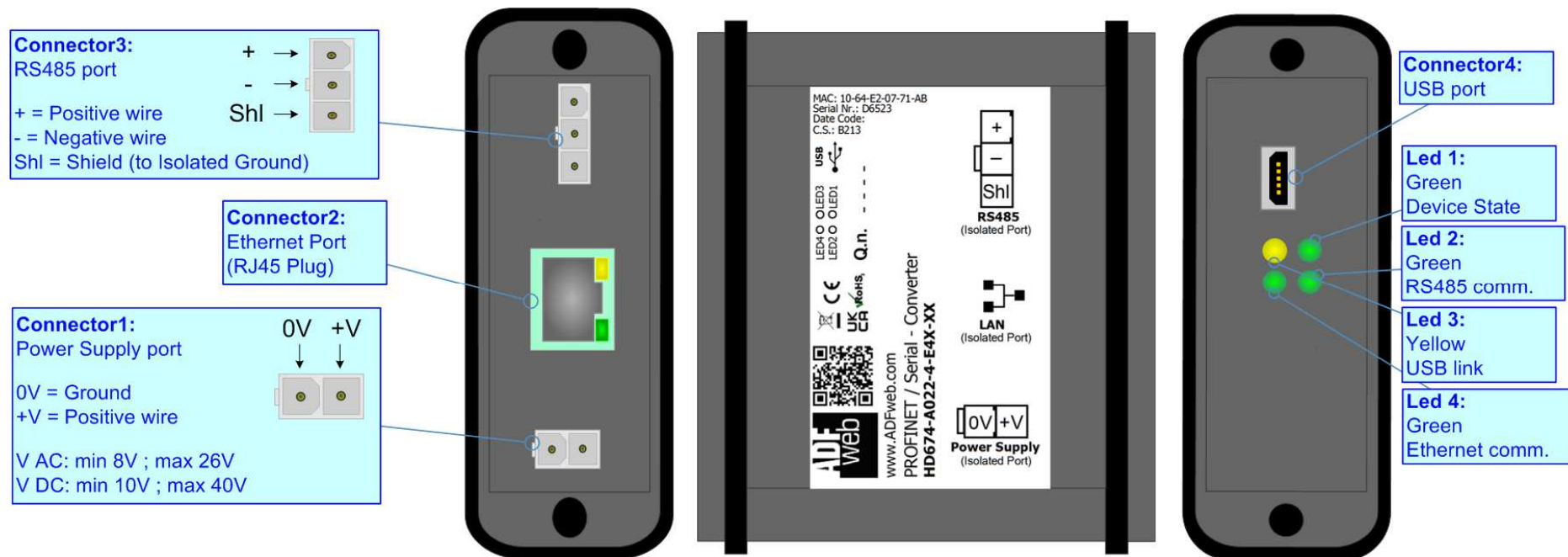

Figure 1c: Connection scheme for HD674-A022-4-E4x

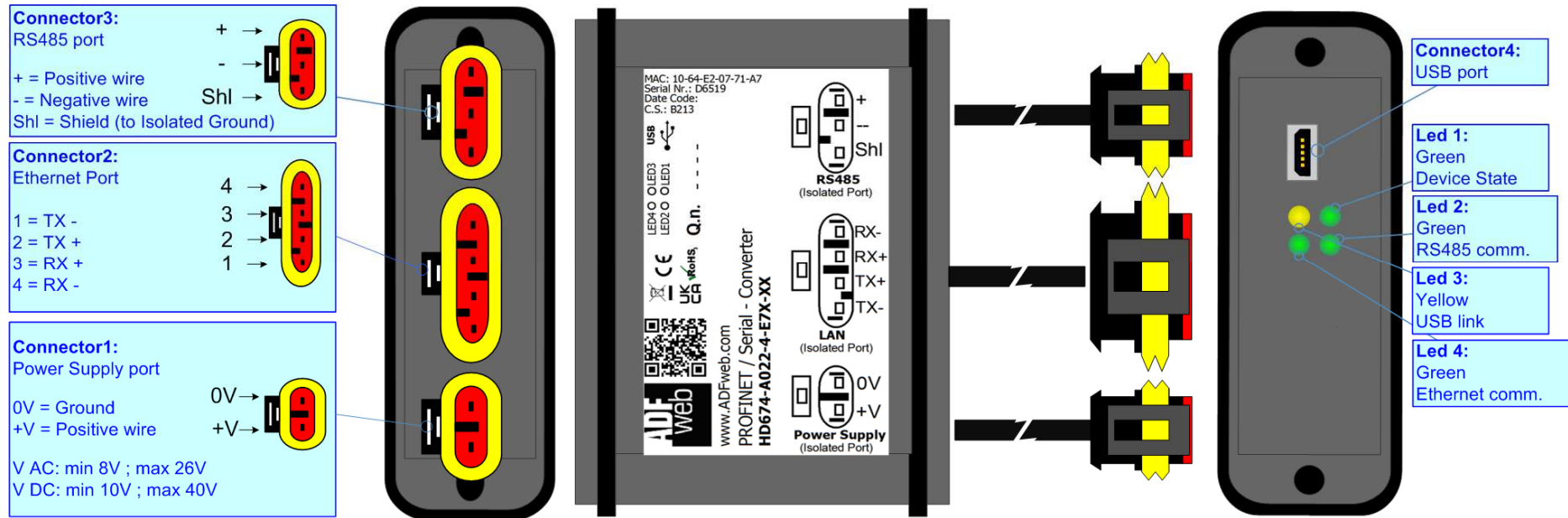

Figure 1d: Connection scheme for HD674-A022-4-E7x

CHARACTERISTICS:

The “**HD674-A022**” series are rugged devices used to interface Serial devices with PROFINET network.

With its particular enclosure, equipped with four fixing lugs, makes available the mounting of the device in any plane surface (horizontal, vertical, oblique).

It is possible to have the device varnished or totally resined and also in both cases with “Mini-Fit®” connectors or “AMP SuperSeal 1.5” connectors. If is resined, the enclosure, like the “AMP SuperSeal 1.5” connectors, is waterproof.

All the four series have these characteristics:

- Triple 4kV isolation between Power Supply / PROFINET / Serial;
- Varnished / Resined (optionally);
- Wide power supply input range: 8...26V AC | 10...40V DC;
- Mini-Fit® / AMP SuperSeal 1.5 connectors;
- Metal enclosure with fixing lugs;
- Possibility to use Metal hose clamps for fixing it without using lugs;
- Microprocessor for data control;
- Wide temperature range: -40°C / 105°C (-40°F / 221°F).

CONFIGURATION:

You need Compositor SW674-A022 software on your PC in order to perform the following:

- Define the parameter of PROFINET line;
- Define the parameter of Serial line;
- Update the device.

POWER SUPPLY:

The devices can be powered between a wide range of tensions. For more details see the two tables below.

	VAC		VDC	
	Vmin	Vmax	Vmin	Vmax
HD674-A022-Exx-xx	8V	26V	10V	40V

Consumption at 24V DC:

Device	W/VA
HD674-A022-Exx-xx	4

Caution: Not reverse the polarity power

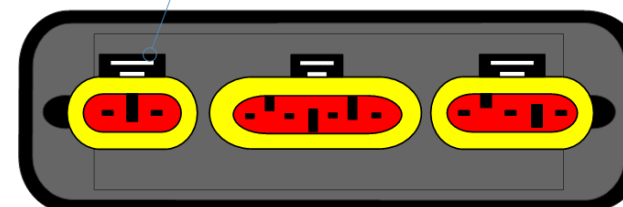
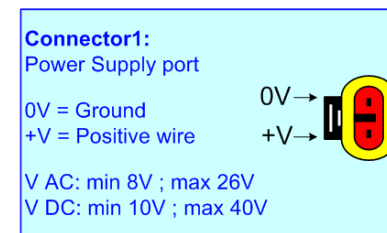
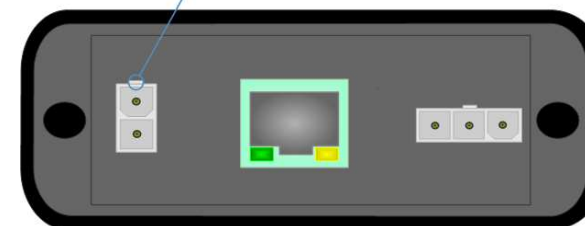
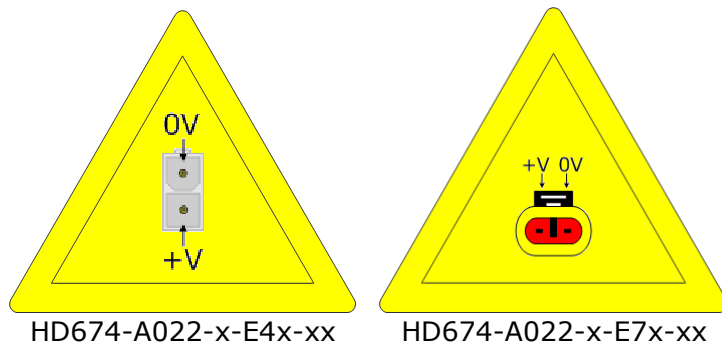

Note: It is possible to use also negative tensions. In this case the polarity must be inverted.

LEDS:

The device has got four LEDs that are used to give information of the functioning status. The various meanings of the LEDs are described in the table below.

LED	Normal Mode	Boot Mode
1: Device state (green)	Blinks slowly (~1Hz)	Blinks quickly: Boot state Blinks very slowly (~0.5Hz): update in progress
2: Serial Communication (green)	Blinks when Serial messages are received	Blinks quickly: Boot state Blinks very slowly (~0.5Hz): update in progress
3: USB Link (yellow)	ON: USB cable inserted OFF: USB cable not inserted	ON: USB cable inserted OFF: USB cable not inserted
4: Ethernet communication (green)	Blinks when Ethernet messages are received	Blinks quickly: Boot state Blinks very slowly (~0.5Hz): update in progress

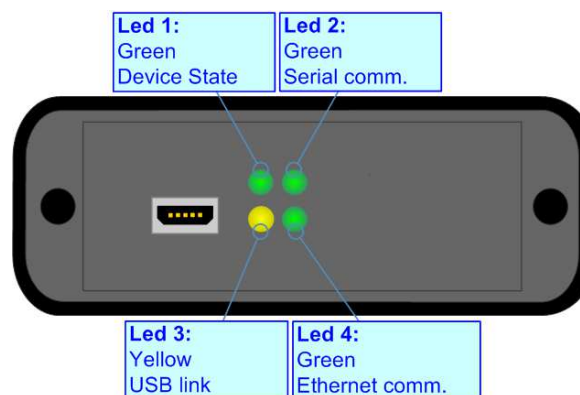

RS232:

The connection of the RS232 in the HD674-A022-2-E4x-xx device must be made with a 3way MiniFit Female connector. The pinout of Male MiniFit connector of the board is at right side of the page.

The connection of the RS232 in the HD67-A022-2-E7x-xx device must be made with a AMP SuperSeal 1.5 Male connector. The pinout of Female connector of the board is at right side of the page.

The maximum length of the cable should be 15m.

Link for Mini-Fit® connectors:

http://www.molex.com/molex/products/group?key=minifit_products&channel=products

Link for SuperSeal 1.5 connectors: <http://www.te.com/catalog/cinf/en/c/10876/956>

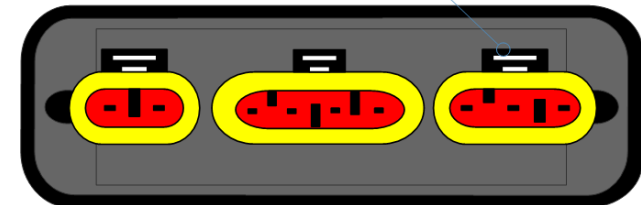
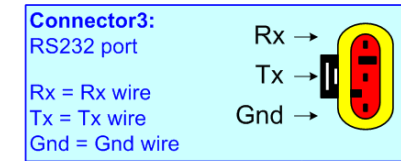
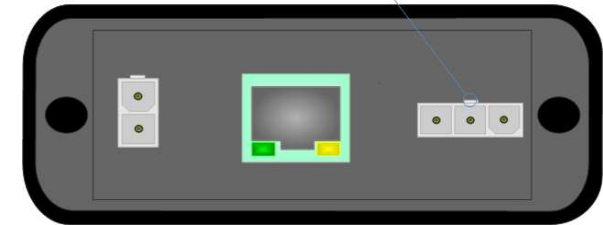
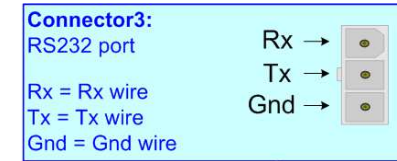

RS485:

The connection of the RS485 in the HD674-A022-4-E4x-xx device must be made with a 3way MiniFit Female connector. The pinout of Male MiniFit connector of the board is at right side of the page.

The connection of the RS485 in the HD67-A022-4-E7x-xx device must be made with a AMP SuperSeal 1.5 Male connector. The pinout of Female connector of the board is at right side of the page.

The termination of RS485 line, with a 120Ω resistor, in the HD674-A022-4-Exx-xx is made internally of the device; when the order is performed. If the device have the RS485 terminated the code is the follow: HD674-A022-4-Exx-Yx; otherwise is this other: HD674-A022-4-Exx-Nx.

The maximum length of the cable should be 1200m (4000 feet).

Here some codes of cables:

- Belden: p/n 8132 - 2x 28AWG stranded twisted pairs conductor + foil shield + braid shield;
- Belden p/n 82842 - 2x 24AWG stranded twisted pairs conductor + foil shield + braid shield;
- Tasker: p/n C521 - 1x 24AWG twisted pair conductor + foil shield + braid shield;
- Tasker: p/n C522 - 2x 24AWG twisted pairs conductor + foil shield + braid shield.

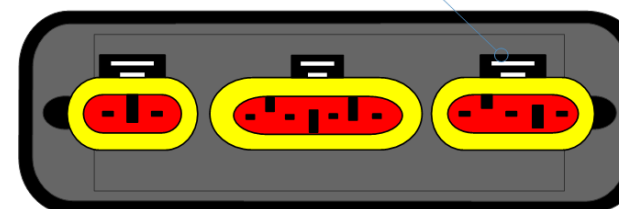
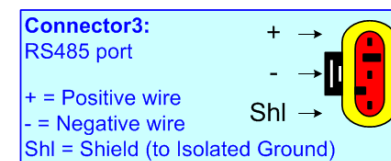
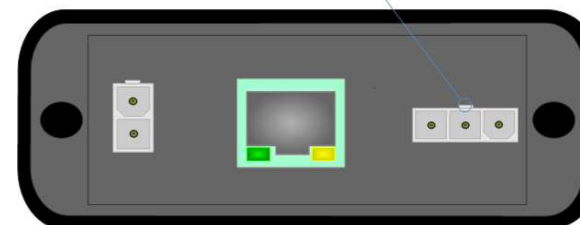

Link for Mini-Fit® connectors: http://www.molex.com/molex/products/group?key=minifit_products&channel=products

Link for SuperSeal 1.5 connectors: <http://www.te.com/catalog/cinf/en/c/10876/956>

ETHERNET:

The connection of Ethernet in the HD674-A022 device must be made with at least a Category 5E cable. The maximum length of the cable should not exceed 100m. The cable has to conform to the T568 norms relative to connections in cat.5 up to 100 Mbps. To connect the device to an Hub/Switch is recommended the use of a straight cable, to connect the device to a PC/PLC/other is recommended the use of a cross cable.

The connection of Ethernet in the HD674-A022-x-E4x-xx device must be made with RJ45 connector.

The connection of the Ethernet in the HD674-A022-x-E7x-xx device must be made with a AMP SuperSeal 1.5 Male connector. The pinout of Female connector of the board is at right side of the page.

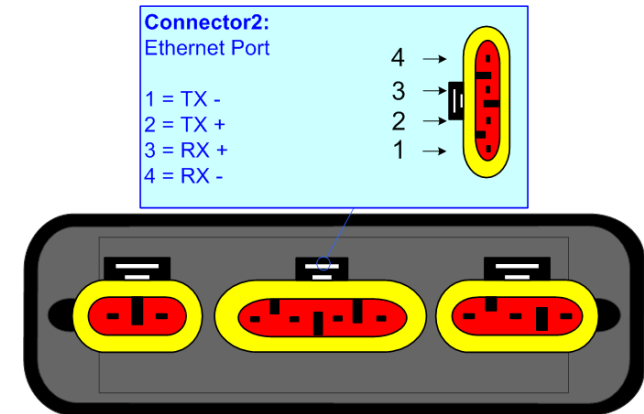

USB:

The USB port is used to start the converter in Boot Mode. It is necessary to use a Micro USB type B cable.

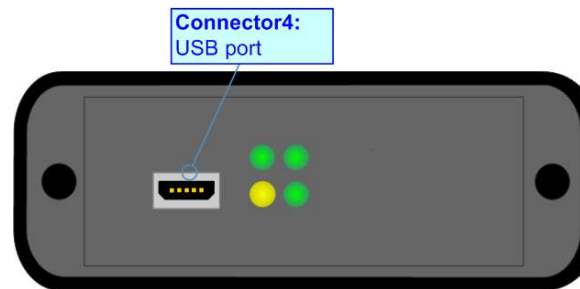

USE OF COMPOSITOR SW674-A022:

To configure the Converter, use the available software that runs with Windows called SW674-A022. It is downloadable from the site www.adfweb.com and its operation is described in this document (*this manual is referenced to the last version of the software present on our web site*). The software works with MSWindows (XP, Vista, Seven, 8, 10 or 11; 32/64bit).

When launching the SW674-A022, the window below appears (Fig. 2).



Note:

It is necessary to have installed .Net Framework 4.

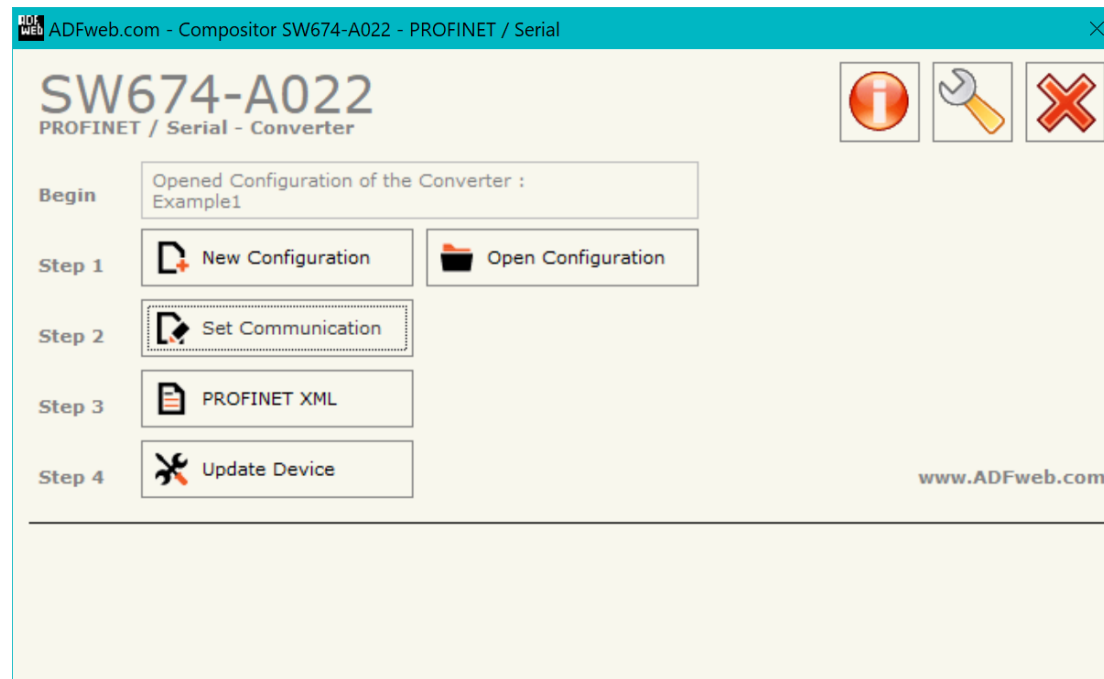

Figure 2: Main window for SW674-A022

NEW CONFIGURATION / OPEN CONFIGURATION:

The “**New Configuration**” button creates the folder which contains the entire device’s configuration.



A device’s configuration can also be imported or exported:

- To clone the configurations of a Programmable “PROFINET / Serial - Converter” in order to configure another device in the same manner, it is necessary to maintain the folder and all its contents;
- To clone a project in order to obtain a different version of the project, it is sufficient to duplicate the project folder with another name and open the new folder with the button “**Open Configuration**”.

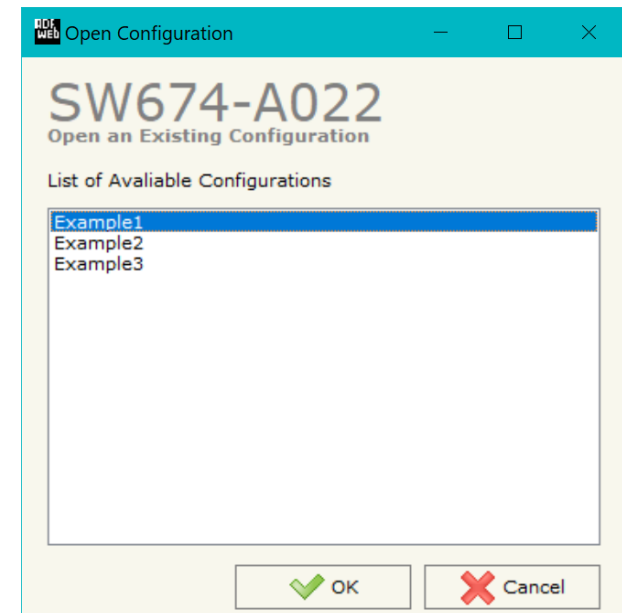

SOFTWARE OPTIONS:

By pressing the “**Settings**” () button there is the possibility to change the language of the software and check the updatings for the compositor.

In the section “Language” it is possible to change the language of the software.

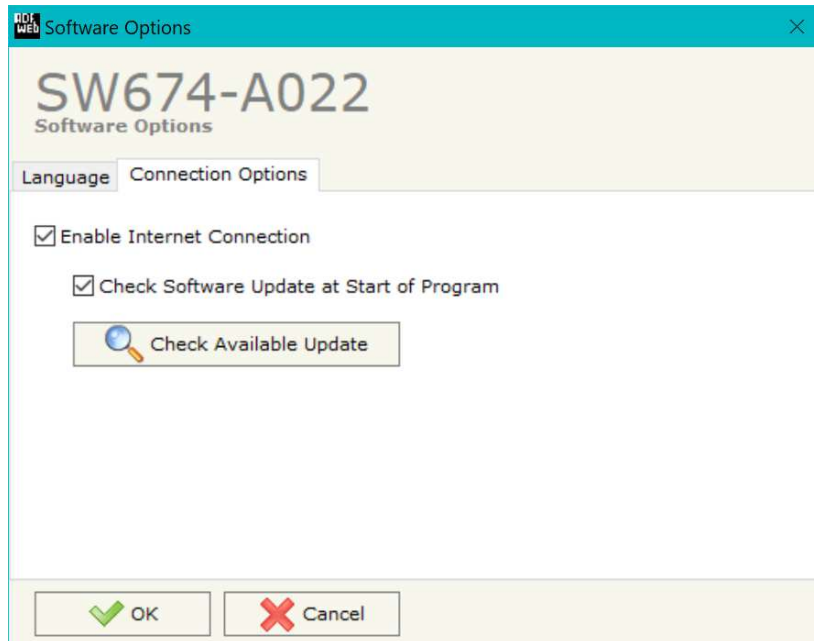

In the section “Connection Options”, it is possible to check if there are some updatings of the software compositor in ADFweb.com website. Checking the option “**Check Software Update at Start of Program**”, the SW674-A022 check automatically if there are updatings when it is launched.

SET COMMUNICATION:

This section defines the fundamental communication parameters of two buses, PROFINET and Serial.

By Pressing the **"Set Communication"** button from the main window for SW674-A022 (Fig. 2), the window "Set Communication" appears (Fig. 3).

The window is divided in two sections, one for the PROFINET and the other for the Serial.

The meanings of the fields for "PROFINET" are:

- In the field **"IP ADDRESS"** the IP address of the converter is defined;
- In the fields **"SUBNET Mask"** the SubNet Mask of the converter is defined;
- In the fields **"GATEWAY"** the default gateway of the network is defined. This feature can be enabled or disabled pressing the Check Box field. This feature is used for going out of the net;
- In the field **"Port"** the port used for PROFINET communication is defined. The port has a fixed value of 34964;
- In the field **"PROFINET Name of Station"** it is possible to assign a name to the PROFINET node;
- In the fields **"PROFINET -> Gateway"** the number of input byte of the converter is defined;
- In the fields **"PROFINET <- Gateway"** the number of output byte of the converter is defined.

The meanings of the fields for the "Serial" section are:

- In the field **"Serial"** the serial to use is defined;
- In the field **"Baudrate"** the baudrate for the serial line is defined;
- In the field **"Parity"** the parity of the serial line is defined.
- In the field **"DataBits"** the number of data bits used for the serial line communication is defined.

 **Note:**

In the fields **"PROFINET -> Gateway"** and **"PROFINET <- Gateway"** insert the number of maximum bytes that are sent/received plus 2. The value can be a maximum of 500 (498 data bytes + 2 fixed).

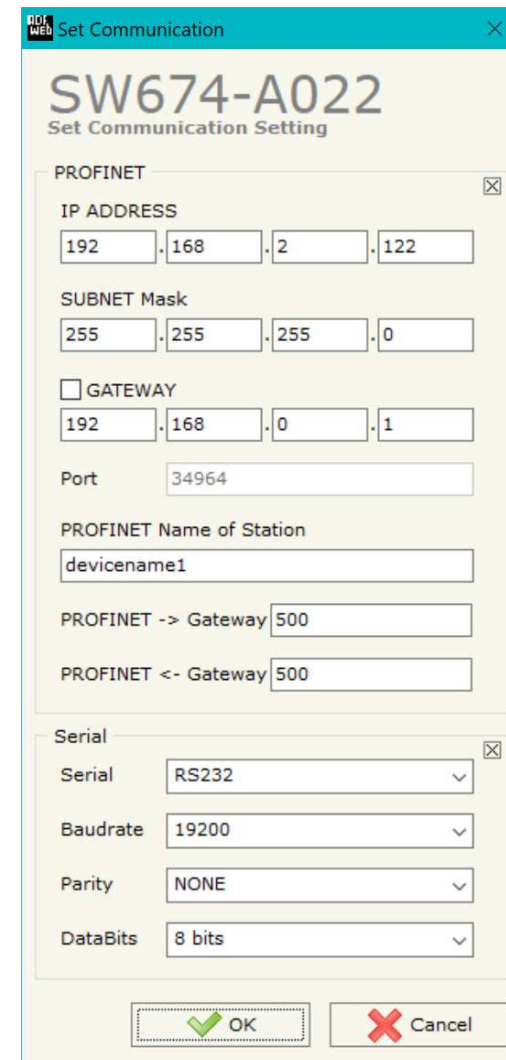

Figure 3: "Set Communication" window

PROFINET XML:

By Pressing the "**PROFINET XML**" button from the main window for SW674-A022 (Fig. 2) it is possible to generate the xml file to be imported into the master PROFINET.

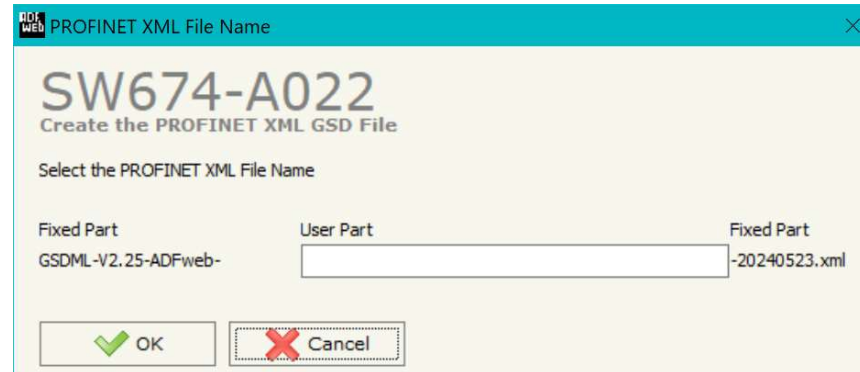

Figure 4: "Create the PROFINET XML GSD File" window

UPDATE DEVICE:

By pressing the **"Update Device"** button, it is possible to load the created Configuration into the device; and also the Firmware, if necessary.

If you don't know the actual IP address of the device you have to use this procedure:

- Connect the USB cable;
- Connect the Ethernet cable;
- Turn ON the converter;
- Insert the IP **"192.168.2.205"**;
- Press the **"Ping"** button, "Device Found! must appear";
- Press the **"Next"** button;
- Select which operations you want to do;
- Press the **"Execute update firmware"** button to start the upload;
- When all the operations are "OK", the updating is done;
- Remove the USB cable.

If you know the actual IP address of the device, you have to use this procedure:

- Turn ON the Device with the Ethernet cable inserted;
- Insert the actual IP of the Converter;
- Press the **"Ping"** button, must appear "Device Found!";
- Press the **"Next"** button;
- Select which operations you want to do;
- Press the **"Execute update firmware"** button to start the upload;
- When all the operations are "OK" the device automatically goes at Normal Mode.

At this point the configuration/firmware on the device is correctly updated.



Figure 5: "Update Device" windows

**Note:**

When you install a new version of the software, if it is the first time it is better you do the update of the Firmware in the HD674-A022 device.

**Note:**

When you receive the device, for the first time, you also have to update the Firmware in the HD674-A022 device.

**Warning:**

If Fig. 6 appears when you try to do the Update try these points before seeking assistance:

- Try to repeat the operations for the updating;
- Try with another PC;
- Try to restart the PC;
- Check the LAN settings;
- If you are using the program inside a Virtual Machine, try to use in the main Operating System;
- If you are using Windows Seven, Vista, 8, 10 or 11 make sure that you have the administrator privileges;
- In case you have to program more than one device, using the "UDP Update", you have to cancel the ARP table every time you connect a new device on Ethernet. For do this you have to launch the "Command Prompt" and write the command "arp -d". Pay attention that with Windows Vista, Seven, 8, 10 or 11 you have to launch the "Command Prompt" with Administrator Rights;
- Pay attention at Firewall lock.

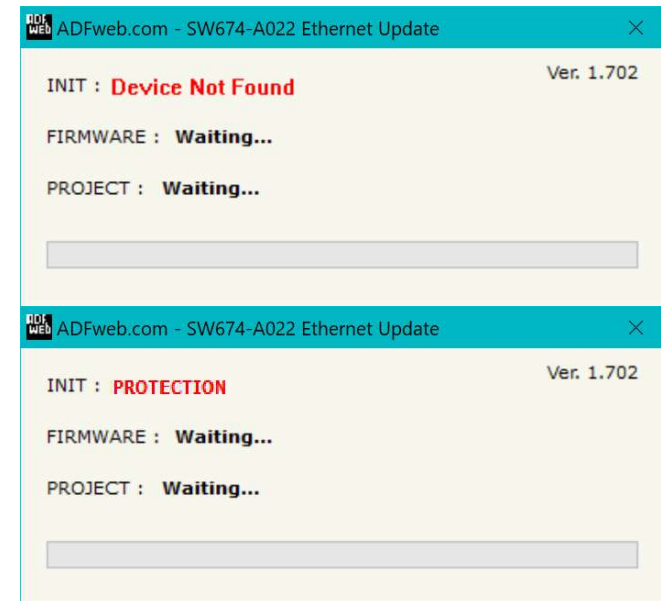

Figure 6: "Protection" window

In the case of HD674-A022 you have to use the software "SW674-A022": www.adfweb.com/download/filefold/SW674-A022.zip.

SERIAL PROTOCOL:



To send/receive PROFINET data from a master device, it is necessary to follow these instructions:

Master PROFINET → HD674-A022

Byte 0	Byte 1	Byte 2	Byte 3	Byte 4	Byte 5	Byte 6
YY	ZZ	Data...data

In the byte ZZ and the less significant bit of YY the length of data that follow must be written; the most significant bit of YY must be toggled every time a new message must be sent on serial.

Byte 0 (YY)								Byte 1 (ZZ)							
Bit 7	Bit 6	Bit 5	Bit 4	Bit 3	Bit 2	Bit 1	Bit 0	Bit 7	Bit 6	Bit 5	Bit 4	Bit 3	Bit 2	Bit 1	Bit 0
	0	0	0	0	0	0									

-  Toggle between 0 and 1
-  0...498 (number of bytes to send on serial)
- 0 "0" must be written

Examples:

- Send on serial 4 bytes: 00 04 01 02 03 04
- Send again the same 4 bytes: 80 04 01 02 03 04
- Send 8 bytes: 00 08 05 06 07 08 09 0A 0B 0C

HD674-A022 → master PROFINET

Byte 0	Byte 1	Byte 2	Byte 3	Byte 4	Byte 7	Byte 6
YY	ZZ	Data...data

In the byte ZZ and the less significant bit of YY the length of data that follow is written; the other bits are used for send a progressive number .

Byte 0 (YY)								Byte 1 (ZZ)							
Bit 7	Bit 6	Bit 5	Bit 4	Bit 3	Bit 2	Bit 1	Bit 0	Bit 7	Bit 6	Bit 5	Bit 4	Bit 3	Bit 2	Bit 1	Bit 0

- 0...127 (counter incremented after every frame received)
- 0...498 (number of bytes received from serial)

Examples:

- Received on serial 4 bytes: 02 04 01 02 03 04
- Received the same 4 bytes again: 04 04 01 02 03 04
- Received 8 bytes: 06 08 05 06 07 08 09 0A 0B 0C



Note:

The time for considering the receiving frame finished is when there is a idle time between bytes of 2tbit.



Note:

If the Converter receives more than 498 bytes in a single frame, the remaining bytes are deleted and only the firsts 498 are sent to the master PROFINET.

MECHANICAL DIMENSIONS:

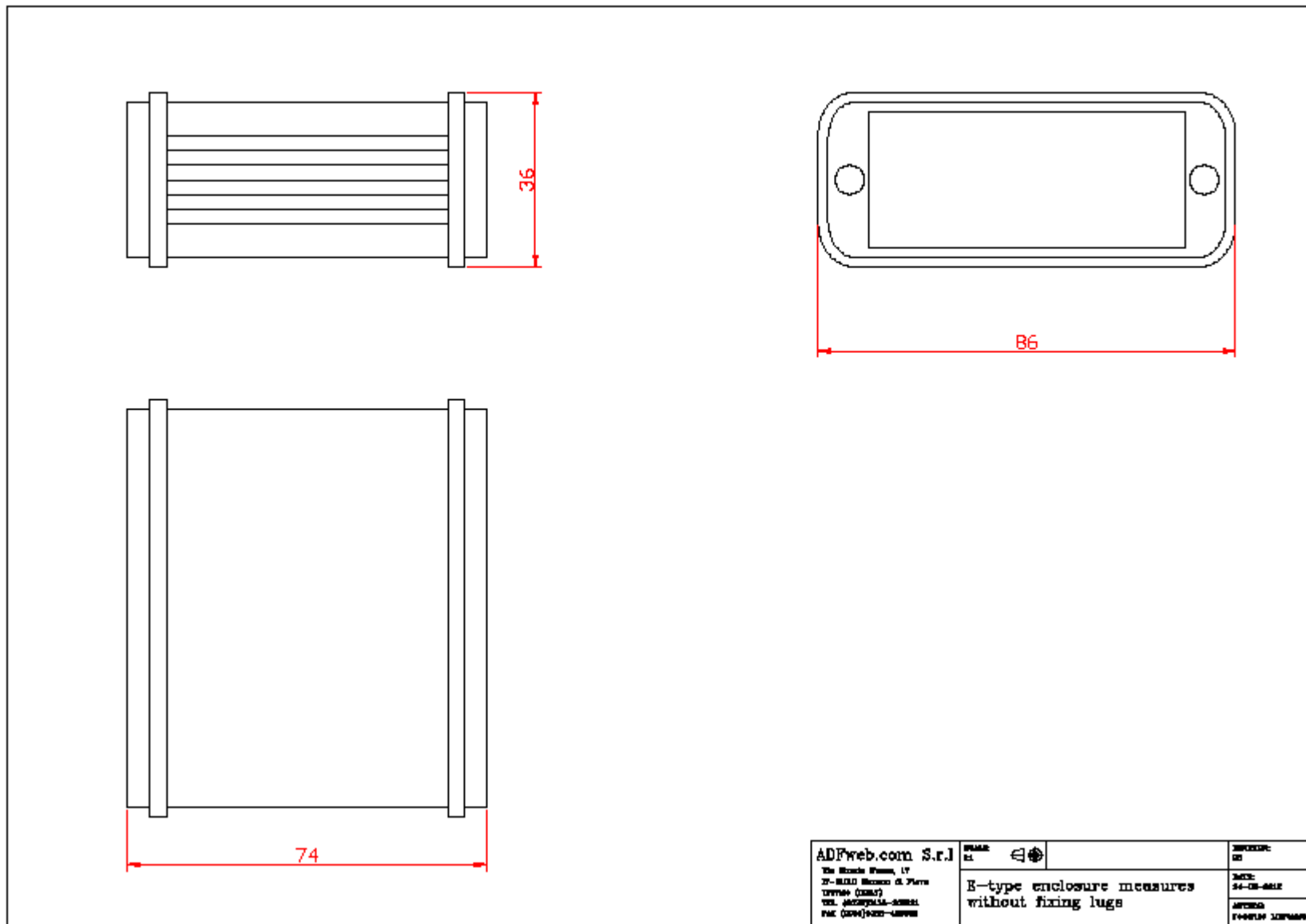

<p>ADFweb.com S.r.l. Via Monte Prato, 17 37-38100 Verona S. Pietro 047546 (04757) TEL. 0475461111-400011 FAX (0475)4621-400001</p>	<p>IPNOME E1</p>  <p>E-type enclosure measures without fixing lugs</p>	<p>REVISIONE: 02</p> <p>DATA: 04-08-2011</p> <p>AUTORE: F. BERTINI</p>
--	---	--

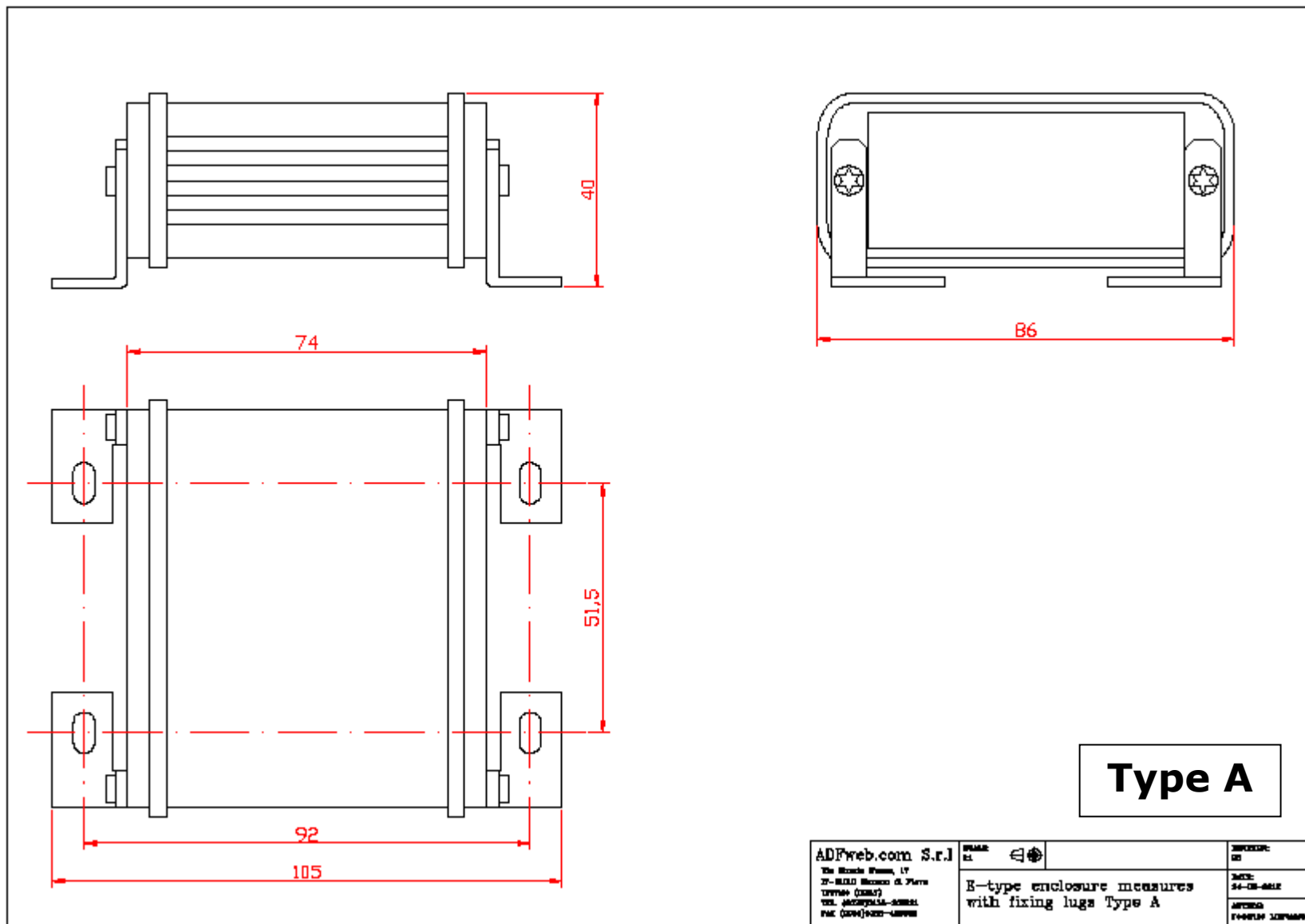

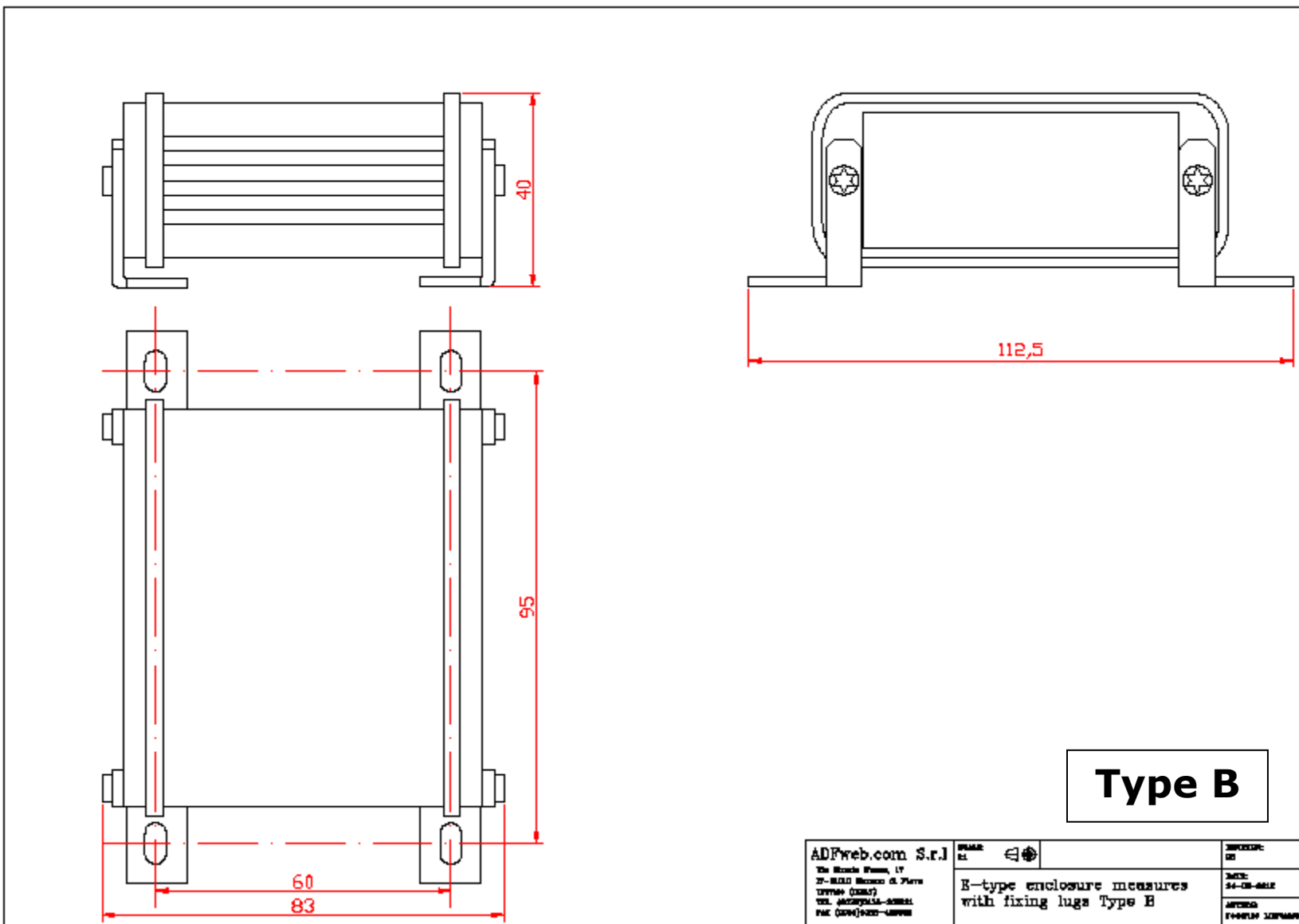

Type B

ADFweb.com S.r.l. Via Salaria Nuova, 17 IT-00198 Roma (RM) - Italy TEL. (06)498111-10000 FAX (06)498111-10000	SYMBOL:	SYMBOL:
	E-type enclosure measures with fixing lugs Type B	
	DATE: 24-08-2012	APPROVED:

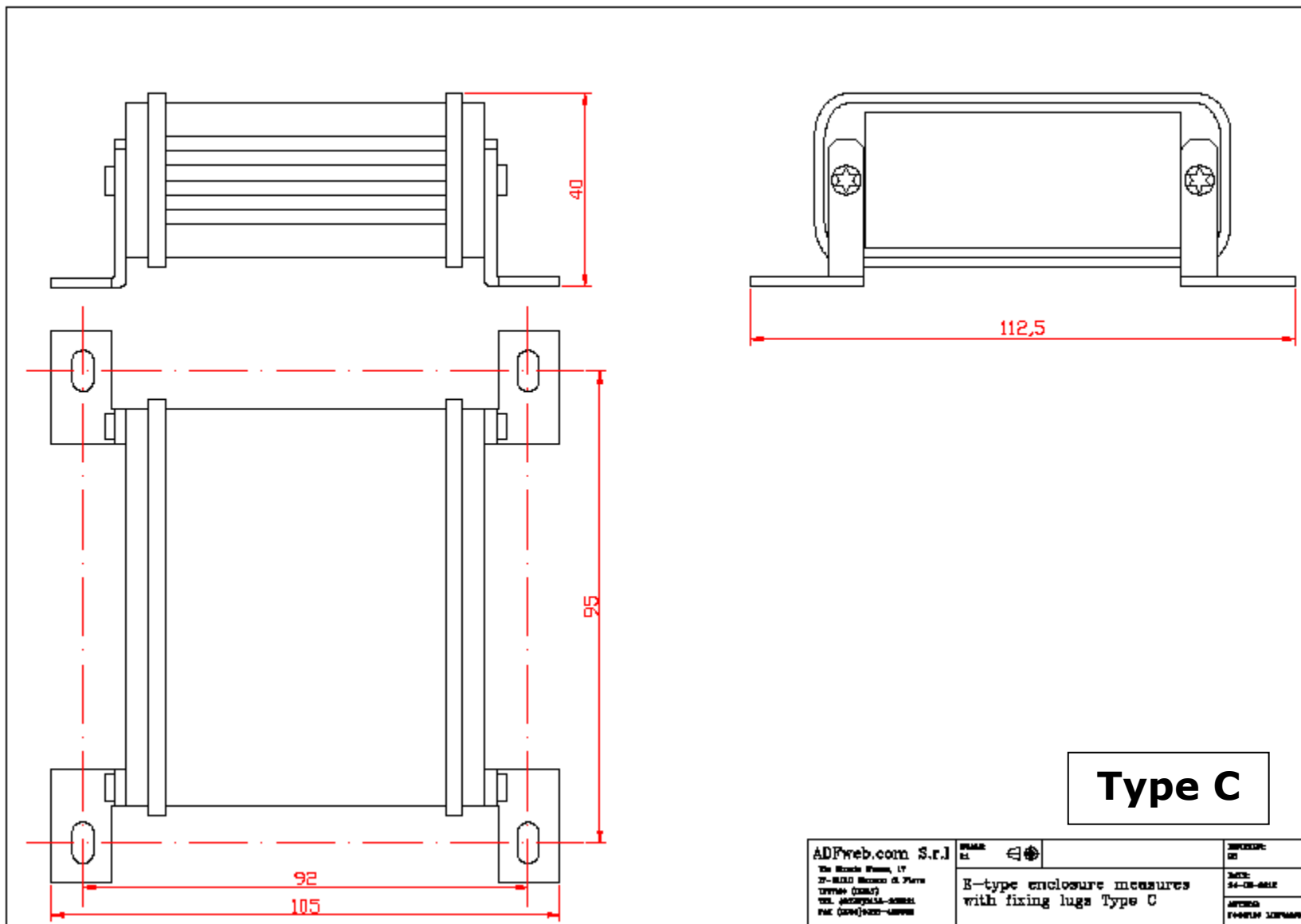

ORDERING INFORMATIONS:

The ordering part number is formed by a valid combination of the following:

HD674-A022 - x - E y z - s f

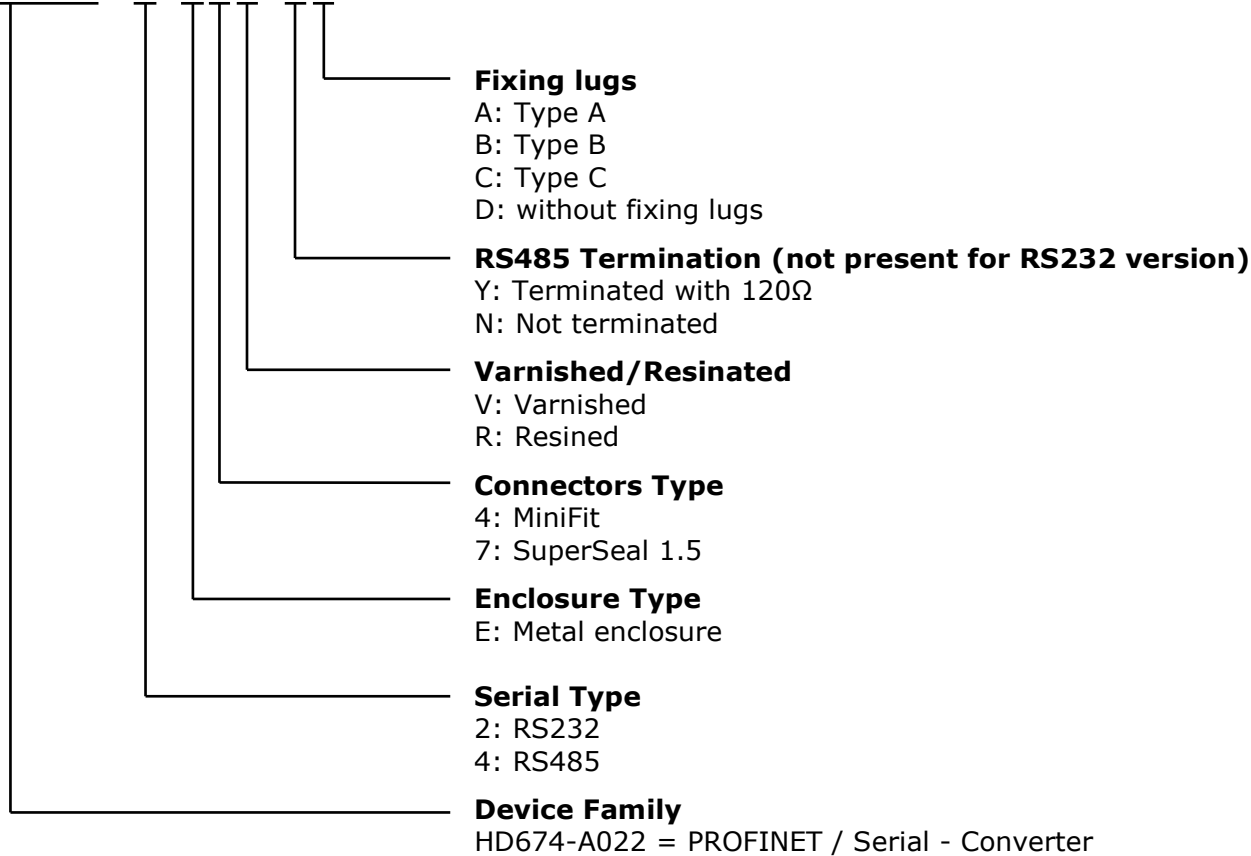

ACCESSORIES:

- Order Code: **AC34001** - Rail DIN - Power Supply 220/240V AC 50/60Hz – 12 V AC
- Order Code: **AC34002** - Rail DIN - Power Supply 110V AC 50/60Hz – 12 V AC
- Order Code: **AC67402** - Cable Super Seal 1.5 MALE 2-pole - 1.0 Meter
- Order Code: **AC67402-3** - Cable Super Seal 1.5 MALE 2-pole - 3.0 Meters
- Order Code: **AC67403** - Cable Super Seal 1.5 MALE 3-pole - 1.0 Meter
- Order Code: **AC67403-3** - Cable Super Seal 1.5 MALE 3-pole - 3.0 Meters
- Order Code: **AC67404** - Cable Super Seal 1.5 MALE 4-pole - 1.0 Meter
- Order Code: **AC67404-3** - Cable Super Seal 1.5 MALE 4-pole - 3.0 Meters
- Order Code: **AC67410** - Accessory Automotive Devices - Support for rail DIN

PLC CONFIGURATION:

The configuration and commissioning of the PROFINET Converter as described on the following pages was accomplished with the help of the TIA Portal software by Siemens. In the case of using a control system from another supplier, refer to attend to the associated documentation.

These are the steps to follow:

- 1) Install the description file of the module.

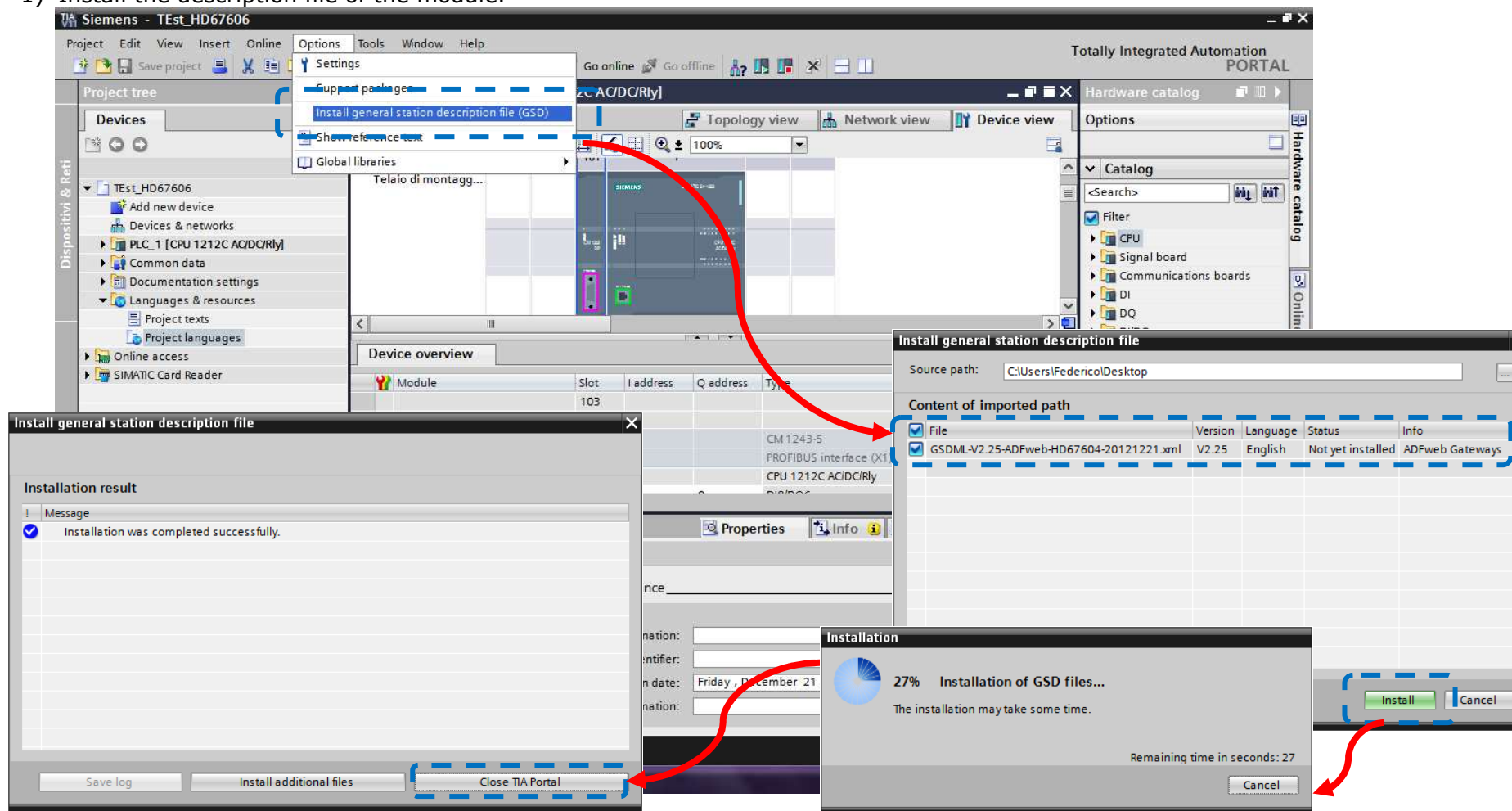

2) Import the module in the network; connect the device to the PLC network and edit the parameters of IP, station name etc.

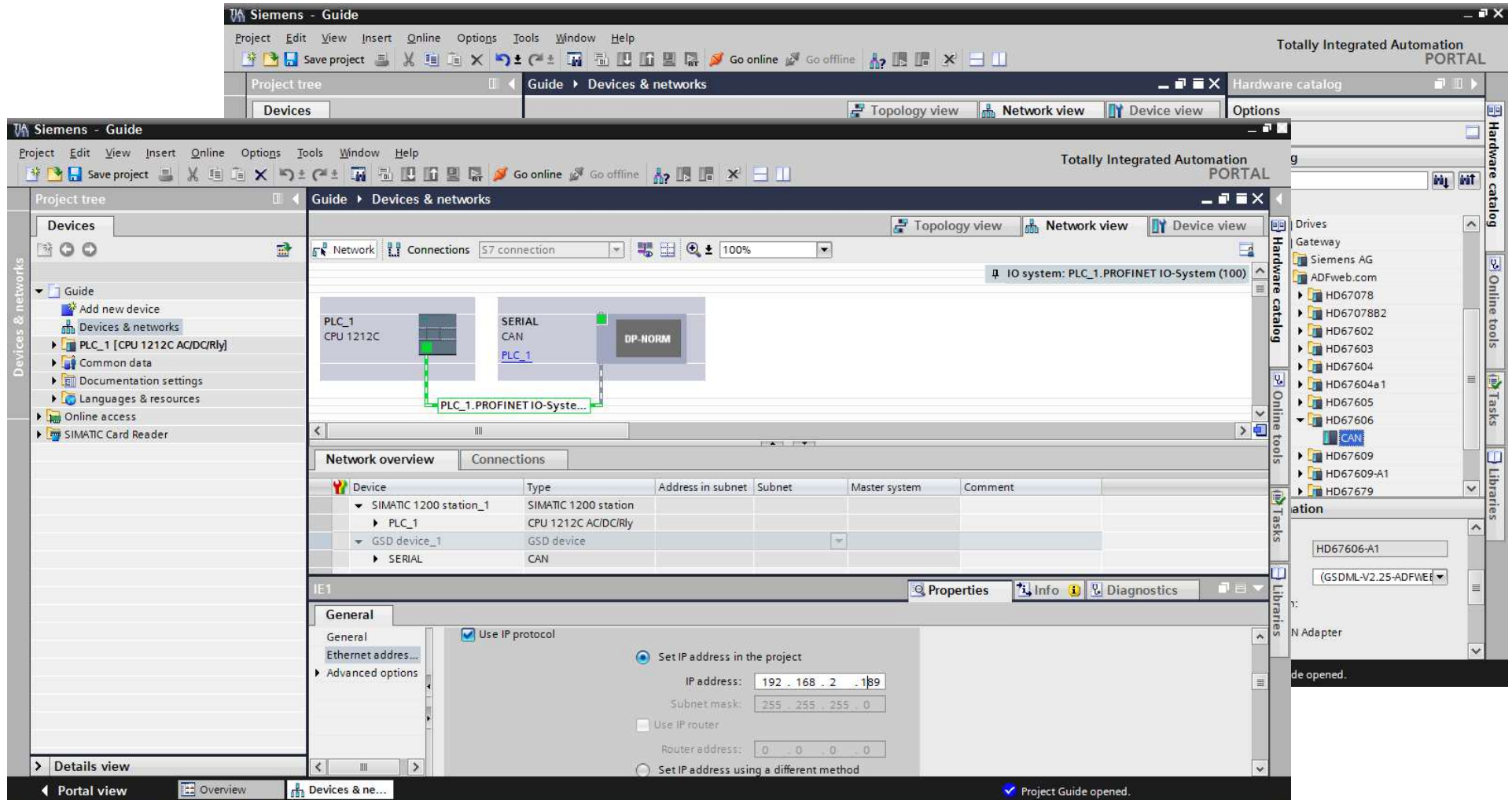

3) Load the configuration into the PLC.

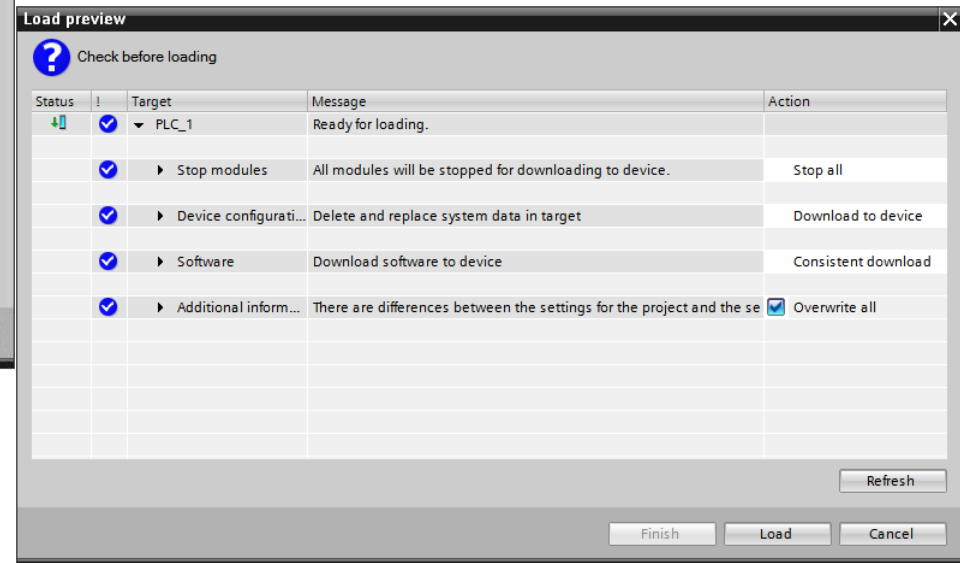
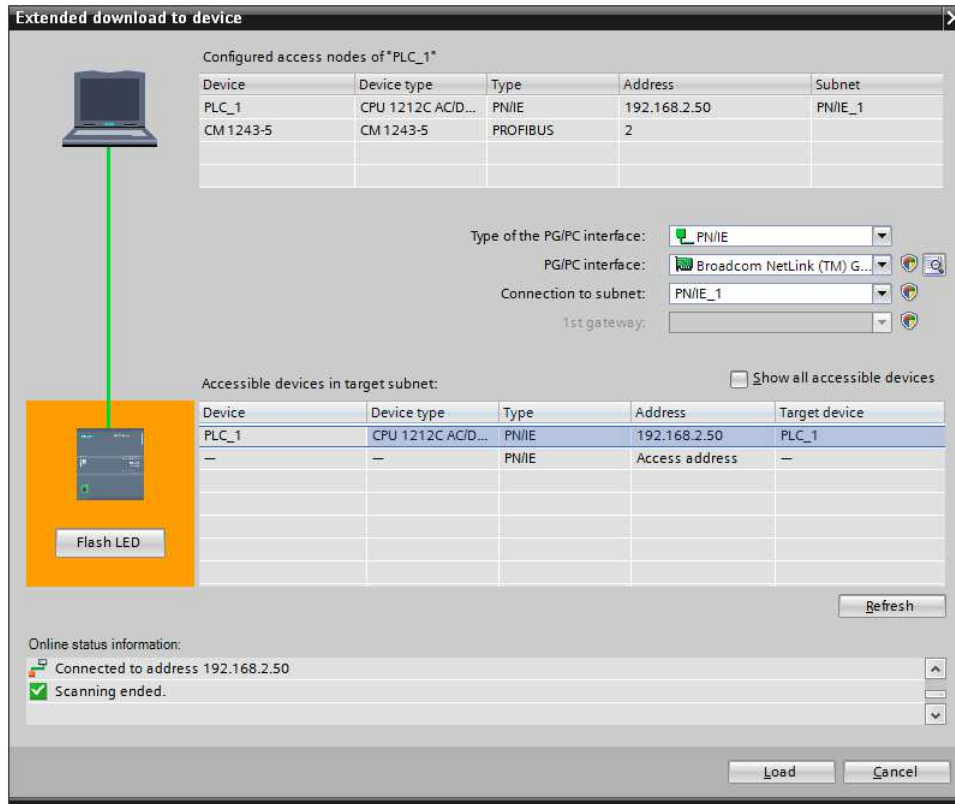

DISCLAIMER:

All technical content within this document can be modified without notice. The content of the document is a under continual renewal. For losses due to fire, earthquake, third party access or other accidents, or intentional or accidental abuse, misuse, or use under abnormal conditions repairs are charged to the user. ADFweb.com S.r.l. will not be liable for accidental loss of use or inability to use this product, such as loss of business income. ADFweb.com S.r.l. shall not be liable for consequences of improper use.

OTHER REGULATIONS AND STANDARDS:**WEEE INFORMATION**

Disposal of old electrical and electronic equipment (as in the European Union and other European countries with separate collection systems).

— This symbol on the product or on its packaging indicates that this product may not be treated as household rubbish. Instead, it should be taken to an applicable collection point for the recycling of electrical and electronic equipment. If the product is disposed correctly, you will help prevent potential negative environmental factors and impact of human health, which could otherwise be caused by inappropriate disposal. The recycling of materials will help to conserve natural resources. For more information about recycling this product, please contact your local city office, your household waste disposal service or the shop where you purchased the product.

RESTRICTION OF HAZARDOUS SUBSTANCES DIRECTIVE

The device respects the 2002/95/EC Directive on the restriction of the use of certain hazardous substances in electrical and electronic equipment (commonly referred to as Restriction of Hazardous Substances Directive or RoHS).

CE MARKING

The product conforms with the essential requirements of the applicable EC directives.

WARRANTIES AND TECHNICAL SUPPORT:

For fast and easy technical support for your ADFweb.com SRL products, consult our internet support at www.adfweb.com.
Otherwise contact us at the address support@adfweb.com

RETURN POLICY:

If while using your product you have any problem and you wish to exchange or repair it, please do the following:

- Obtain a Product Return Number (PRN) from our internet support at www.adfweb.com. Together with the request, you need to provide detailed information about the problem.
- Send the product to the address provided with the PRN, having prepaid the shipping costs (shipment costs billed to us will not be accepted).

If the product is within the warranty of twelve months, it will be repaired or exchanged and returned within three weeks. If the product is no longer under warranty, you will receive a repair estimate.



ADFweb.com S.r.l.
Via Strada Nuova, 17
IT-31010 Mareno di Piave
TREVISO (Italy)
Phone +39.0438.30.91.31
Fax +39.0438.49.20.99
www.adfweb.com

