

User Manual

Revision 1.100
English

RS232/RS485/RS422 / Modbus TCP - Converter

(Order Code: HD67521-A1, HD67521-422-A1)

For Website information:

www.adfweb.com?Product=HD67521

For Price information:

www.adfweb.com?Price=HD67521-A1

www.adfweb.com?Price=HD67521-422-A1

Benefits and Main Features:

- ⊕ 32mm Rail DIN mount
- ⊕ Wide supply input range
- ⊕ Temperature range: -40°C/+85°C (-40°F/+185°F)



User Manual

For other Gateways / Bridges:

Serial / Modbus - converter

See also the following links:

www.adfweb.com?product=HD67501 (Modbus Slave)

CAN bus to Modbus

See also the following links:

www.adfweb.com?product=HD67011 (Modbus RTU Master)

www.adfweb.com?product=HD67012 (Modbus RTU Slave)

www.adfweb.com?product=HD67514 (Modbus TCP Master)

www.adfweb.com?product=HD67515 (Modbus TCP Server)

Do you have an your customer protocol?

See the following links:

www.adfweb.com?Product=HD67003

Do you need to choose a device? do you want help?

Ask it to the following link:

www.adfweb.com?Cmd=helpme



INDEX:

	Page
INDEX	2
UPDATED DOCUMENTATION	2
REVISION LIST	2
WARNING	2
TRADEMARKS	2
SECURITY ALERT	3
EXAMPLE OF CONNECTION	4
CONNECTION SCHEME	5
CHARACTERISTICS	7
CONFIGURATION	7
POWER SUPPLY	8
FUNCTION MODES	9
LEDS	10
RS485	11
RS422	12
RS232	13
ETHERNET	14
USE OF COMPOSITOR SW67521	15
NEW CONFIGURATION / OPEN CONFIGURATION	16
SOFTWARE OPTIONS	17
SET COMMUNICATION	19
UPDATE DEVICE	21
MECHANICAL DIMENSIONS	23
ORDER CODES	25
ACCESSORIES	25
DISCLAIMER	26
OTHER REGULATIONS AND STANDARDS	26
WARRANTIES AND TECHNICAL SUPPORT	27
RETURN POLICY	27

UPDATED DOCUMENTATION:

Dear customer, we thank you for your attention and we remind you that you need to check that the following document is:

- Updated
- Related to the product you own

To obtain the most recently updated document, note the “document code” that appears at the top right-hand corner of each page of this document.

With this “Document Code” go to web page www.adfweb.com/download/ and search for the corresponding code on the page. Click on the proper “Document Code” and download the updates.

REVISION LIST:

Revision	Date	Author	Chapter	Description
1.000	09/05/2016	Ff	All	First release version
1.001	02/03/2017	Ff	All	Revision
1.100	23/06/2025	Mdb	All	New design

WARNING:

ADFweb.com reserves the right to change information in this manual about our product without warning.

ADFweb.com is not responsible for any error this manual may contain.

TRADEMARKS:

All trademarks mentioned in this document belong to their respective owners.

SECURITY ALERT:**GENERAL INFORMATION**

To ensure safe operation, the device must be operated according to the instructions in the manual. When using the device are required for each individual application, legal and safety regulation. The same applies also when using accessories.

INTENDED USE

Machines and systems must be designed so the faulty conditions do not lead to a dangerous situation for the operator (i.e. independent limit switches, mechanical interlocks, etc.).

QUALIFIED PERSONNEL

The device can be used only by qualified personnel, strictly in accordance with the specifications.

Qualified personnel are persons who are familiar with the installation, assembly, commissioning and operation of this equipment and who have appropriate qualifications for their job.

RESIDUAL RISKS

The device is state of the art and is safe. The instrument can represent a potential hazard if they are inappropriately installed and operated by personnel untrained. These instructions refer to residual risks with the following symbol:



This symbol indicates that non-observance of the safety instructions is danger for people to serious injury or death and / or the possibility of damage.

CE CONFORMITY

The declaration is made by us. You can send an email to support@adfweb.com or give us a call if you need it.

EXAMPLE OF CONNECTION:

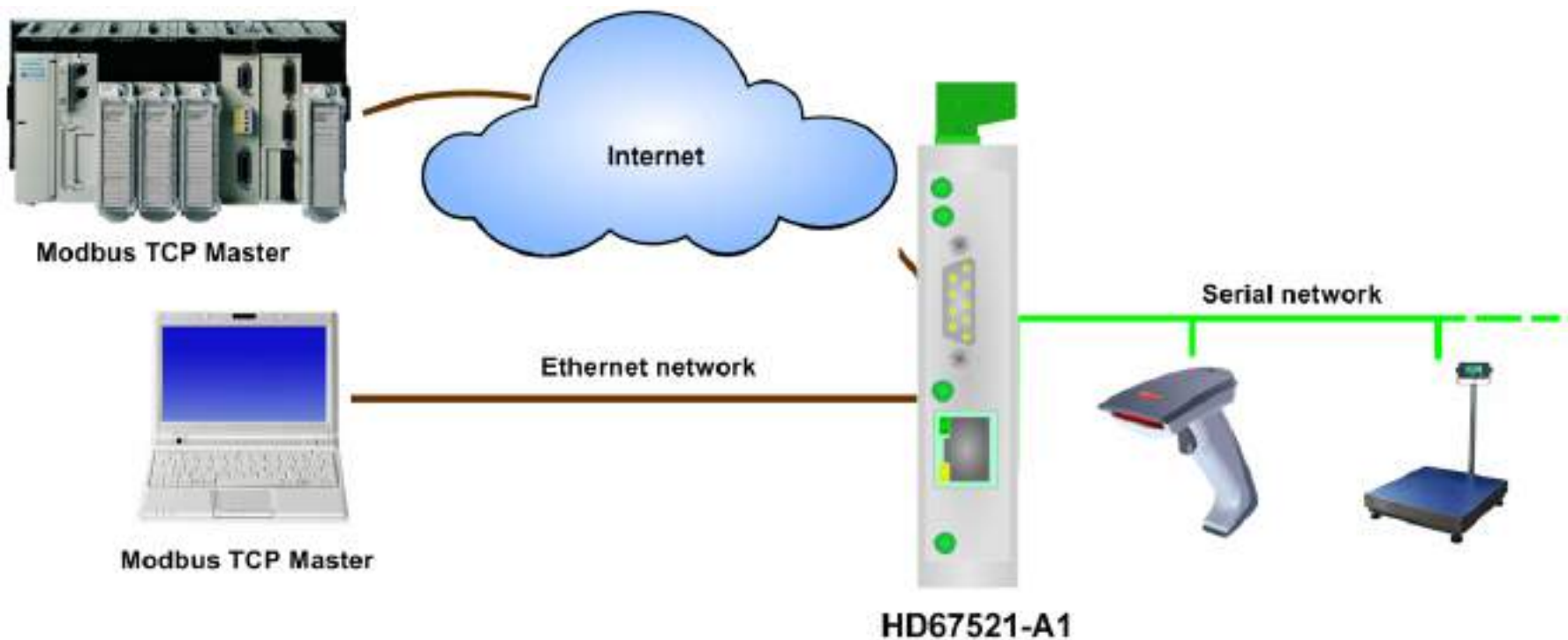

CONNECTION SCHEME:

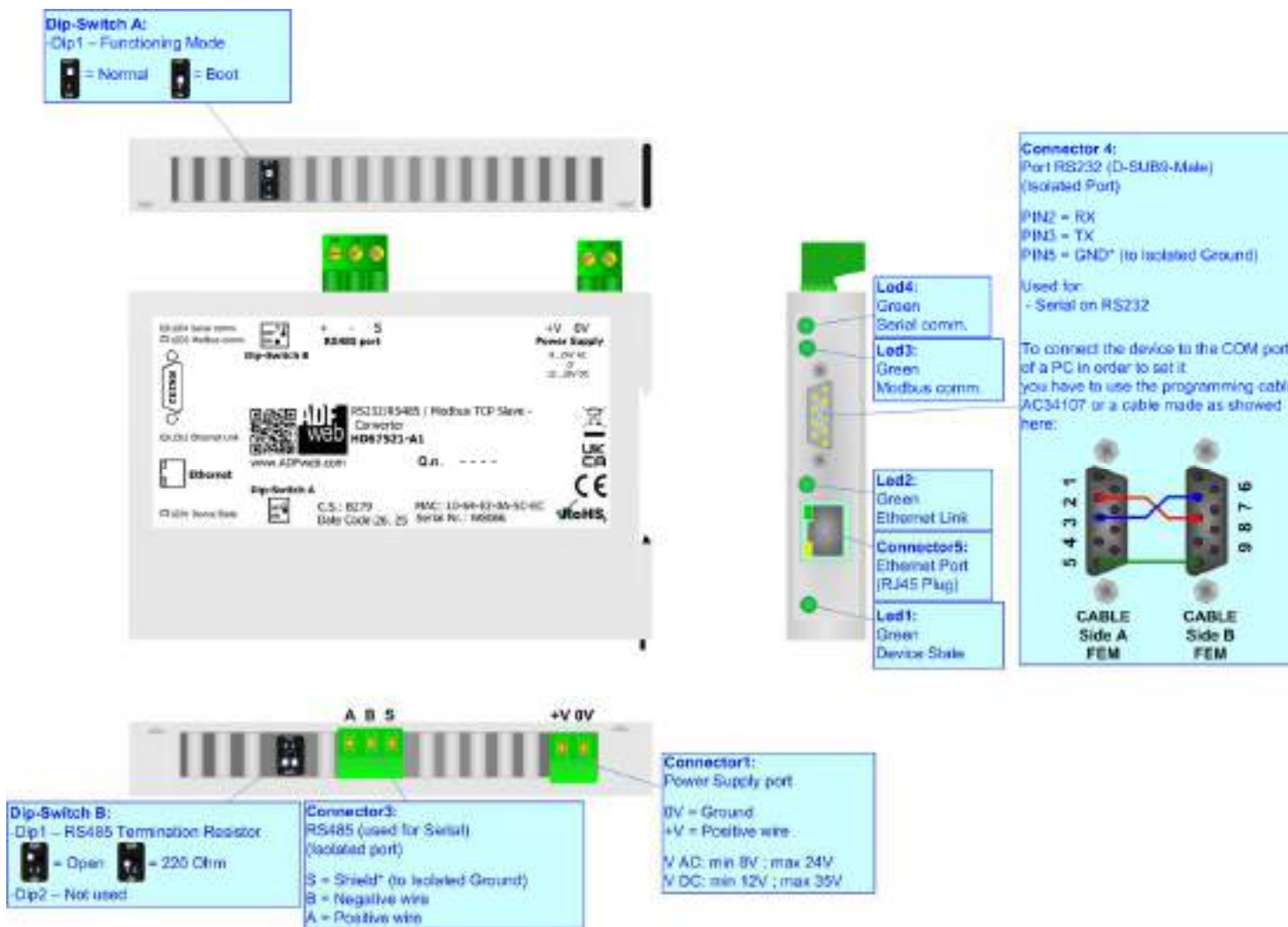

Figure 1a: Connection scheme for HD67521-A1

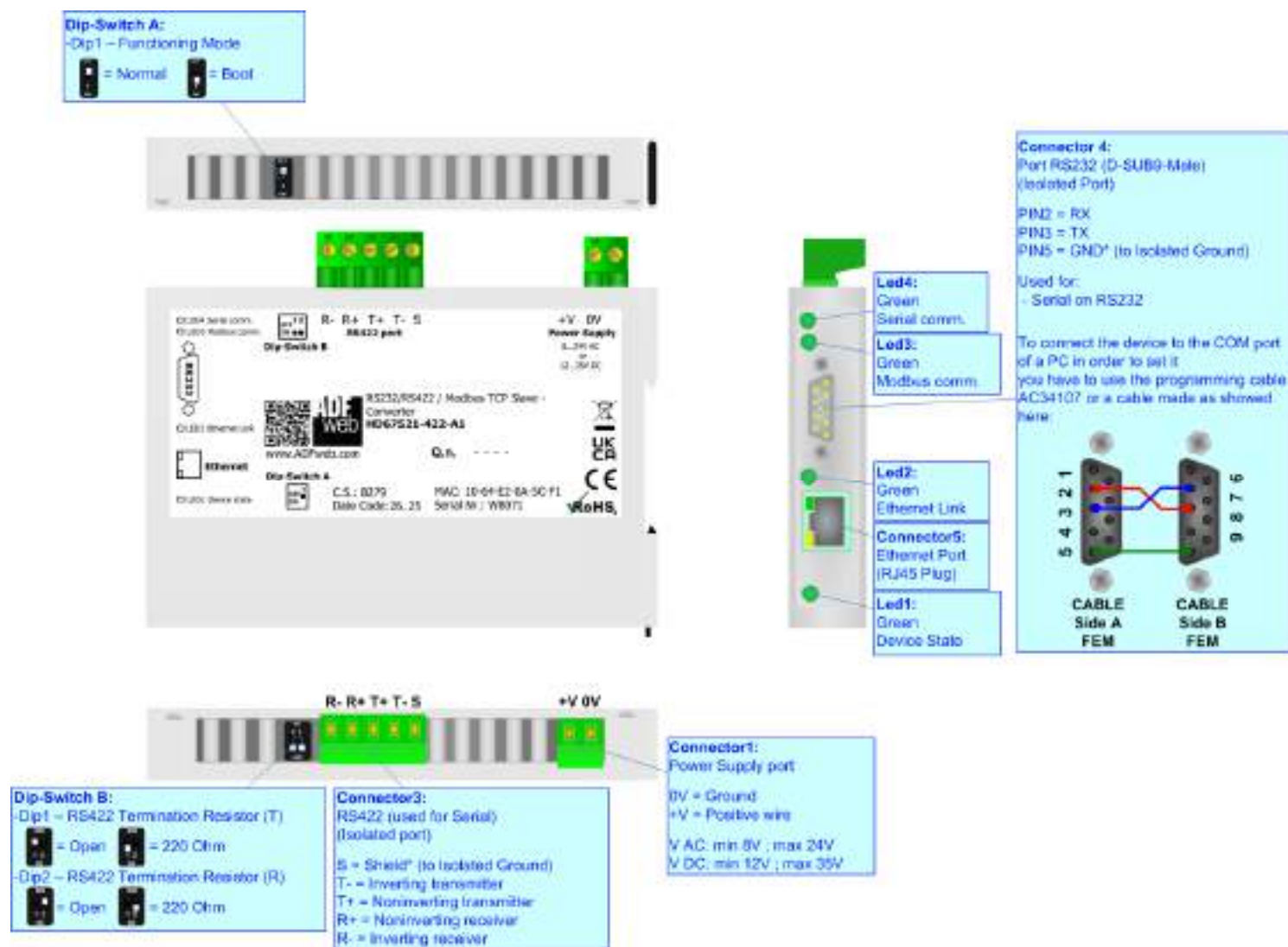

Figure 1b: Connection scheme for HD67521-422-A1

CHARACTERISTICS:

The "RS232/RS485/RS422 / Modbus TCP – Converter" allows the following characteristics:

- two-directional information between networks Serial and Modbus TCP;
- electrical isolation between Serial – Modbus TCP, Power Supply – Modbus TCP, Power Supply – Serial;
- Mountable on Rail DIN;
- Wide power supply input range: 8...24V AC or 12...35V DC;
- Wide temperature range: -40°C / +85°C [-40°F / +185°F].

CONFIGURATION:

You need Compositor SW67521 software on your PC in order to perform the following:

- Define the parameter of Serial;
- Define the parameter of Modbus TCP;
- Update the device.

POWER SUPPLY:

The devices can be powered at 8...24V AC and 12...35V DC. The consumption depends to the code of the device. For more details see the two tables below.

VAC		VDC	
Vmin	Vmax	Vmin	Vmax
8V	24V	12V	35V

Consumption at 24V DC:

Device	Consumption [W/VA]
HD67521-A1	3.5
HD67521-422-A1	3.5



Caution: Not reverse the polarity power



HD67521-A1
HD67521-422-A1



Connector1:
Power Supply port
0V = Ground
+V = Positive wire
V AC: min 8V ; max 24V
V DC: min 12V ; max 35V

FUNCTION MODES:

The device has got two function modes depending on the position of the 'Dip1 of Dip-Switch A':

- The first, with 'Dip1 of Dip-Switch A' at "OFF" position, is used for the normal working of the device.
- The second, with 'Dip1 of Dip-Switch A' at "ON" position, is used for uploading the Project and/or Firmware.

For the operations to follow for the updating, see 'UPDATE DEVICE' section.

According to the functioning mode, the LEDs will have specific functions, see 'LEDS' section.

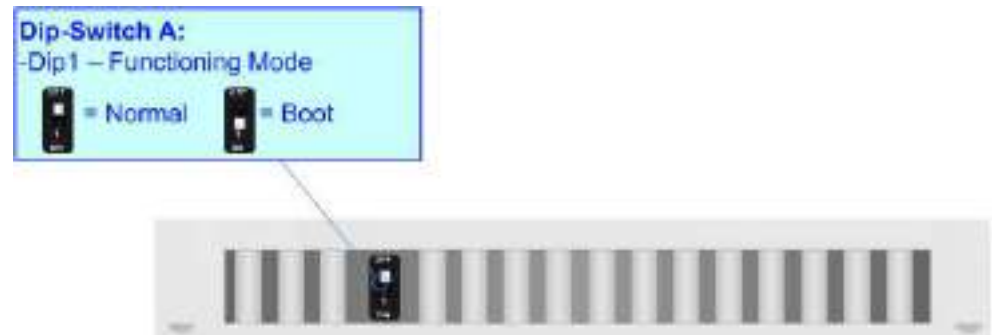

LEDS:

The device has got four LEDs that are used to give information of the functioning status. The various meanings of the LEDs are described in the table below.

LED	Normal Mode	Boot Mode
1: Device State (green)	Blinks slowly (~1Hz)	Blinks quickly: Boot state Blinks very slowly (~0.5Hz): update in progress
2: Ethernet Link (green)	ON: Ethernet cable connected OFF: Ethernet cable disconnected	ON: Ethernet cable connected OFF: Ethernet cable disconnected
3: Modbus comm. (green)	Blinks when Modbus TCP frames are received	Blinks quickly: Boot state Blinks very slowly (~0.5Hz): update in progress
4: Serial comm. (green)	Blinks when Serial frames are received	Blinks quickly: Boot state Blinks very slowly (~0.5Hz): update in progress



RS485:

For terminate the RS485 line with a 220Ω resistor it is necessary to put ON dip 1, like in figure.



The maximum length of the cable should be 1200m (4000 feet).

Here some codes of cables:

- Belden: p/n 8132 - 2x 28AWG stranded twisted pairs conductor + foil shield + braid shield;
- Belden p/n 82842 - 2x 24AWG stranded twisted pairs conductor + foil shield + braid shield;
- Tasker: p/n C521 - 1x 24AWG twisted pair conductor + foil shield + braid shield;
- Tasker: p/n C522 - 2x 24AWG twisted pairs conductor + foil shield + braid shield.

RS422:

For terminate the RS422 line with a 220Ω resistor it is necessary to put ON dip 1 for T line and/or put ON dip 2 for R line, like in figure.

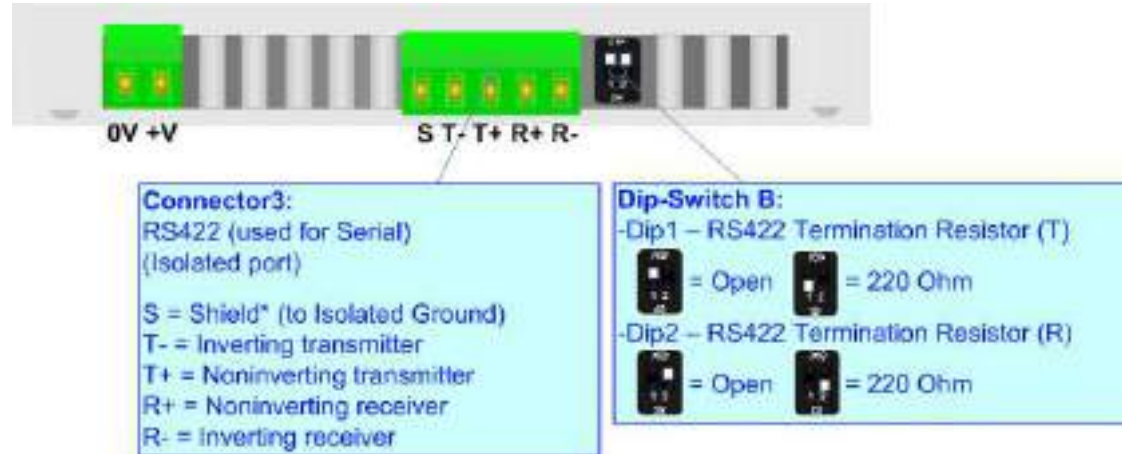

The maximum length of the cable should be 1200m (4000 feet).

RS232:

The connection from RS232 socket to a serial port (example one from a personal computer) must be made with a Null Modem cable (a serial cable where the pins 2 and 3 are crossed). It is recommended that the RS232 cable not exceed 15 meters.

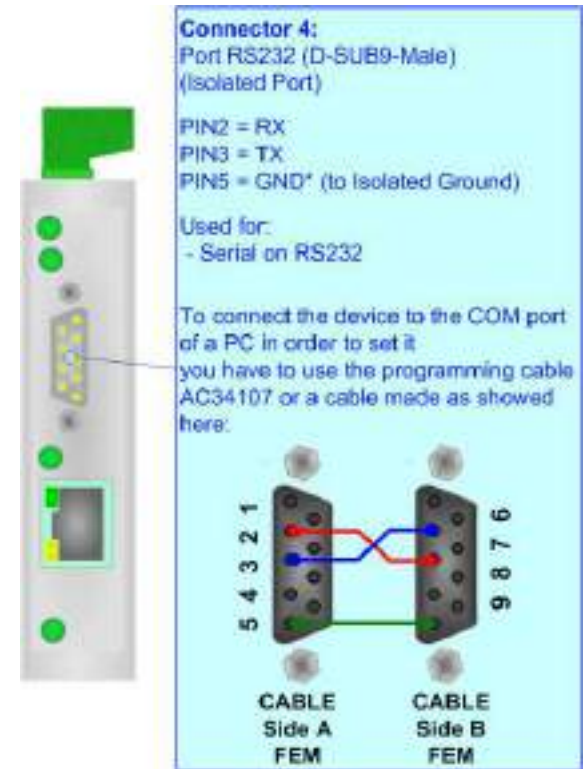

ETHERNET:

The Ethernet connection must be made using Connector5 of HD67521 with at least a Category 5E cable. The maximum length of the cable should not exceed 100m. The cable has to conform to the T568 norms relative to connections in cat.5 up to 100 Mbps. To connect the device to a Hub/Switch the use of a straight cable is recommended. To connect the device to a PC/PLC/other the use of a cross cable is recommended.



USE OF COMPOSITOR SW67521:

To configure the Converter, use the available software that runs with Windows called SW67521. It is downloadable on the site www.adfweb.com and its operation is described in this document. *(This manual is referenced to the last version of the software present on our web site)*. The software works with MSWindows (XP, Vista, Seven, 8, 10 or 11; 32/64bit).

When launching the SW67521, the window below appears (Fig. 2).

 **Note:**
It is necessary to have installed .Net Framework 4.

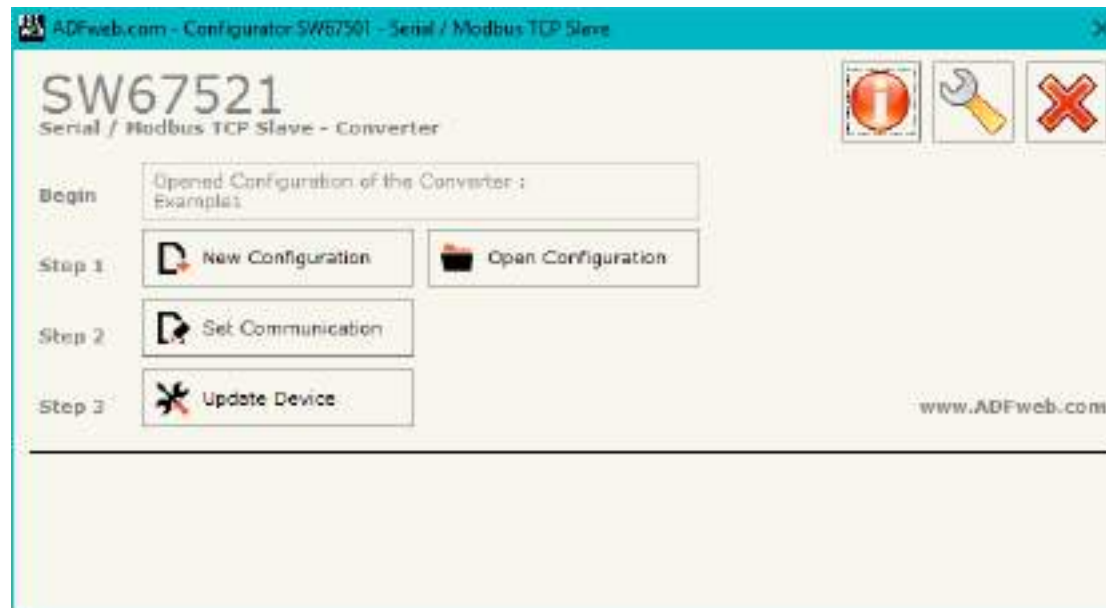

Figure 2: Main window for SW67521

NEW CONFIGURATION / OPEN CONFIGURATION:

The **"New Configuration"** button creates the folder which contains the entire device's configuration.



A device's configuration can also be imported or exported:

- To clone the configurations of a programmable "RS232/RS485/RS422 / Modbus TCP - Converter" in order to configure another device in the same manner, it is necessary to maintain the folder and all its contents;
- To clone a project in order to obtain a different version of the project, it is sufficient to duplicate the project folder with another name and open the new folder with the button **"Open Configuration"**.



SOFTWARE OPTIONS:

By pressing the “**Settings**” () button there is the possibility to change the language of the software and check the updatings for the compositor.

In the section “Language” it is possible to change the language of the software.

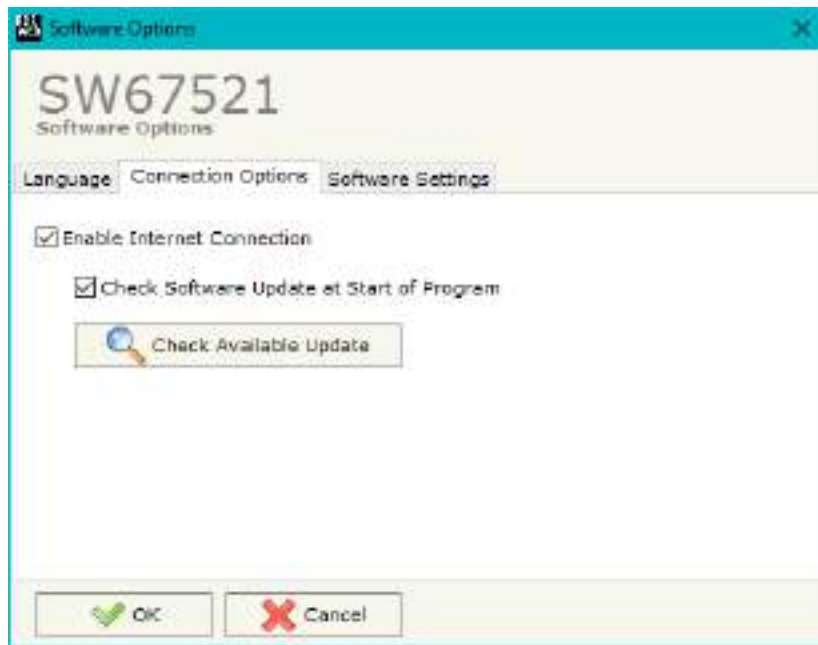

In the section “Connection Options”, it is possible to check if there are some updatings of the software compositor in ADFweb.com website. Checking the option “**Check Software Update at Start of Program**”, the SW67521 check automatically if there are updatings when it is launched.



In the section "Software Settings", it is possible to enable/disable some keyboard's commands for an easier navigation inside the tables contained in the different sections of the software.

SET COMMUNICATION:

This section defines the fundamental communication parameters of two Buses, Serial and Modbus TCP.

By pressing the **"Set Communication"** button from the main window for SW67521 (Fig. 2) the window "Set communication" appears (Fig. 3).

This window is divided in two sections, one to configure the Serial Network and the other for Modbus TCP.

The means for the fields for the "Serial" are:

- In the field **"Serial"** the type of serial port used is defined;
- In the field **"Baudrate"** the baud rate for the Serial side is defined;
- In the field **"Parity"** the parity for the Serial side is defined;
- In the field **"Data Bits"** the number of Data Bits for the Serial side is defined;
- If the field **"Send Type"** the transmission type is defined:
 - "End Character": the end of the string is defined by a specific chars defined in the field **"End Character"**;
 - "Num Bytes on Control Word": the serial string will have the length specified in the Control Word;
 - "Fix Num Bytes": the serial string will have fixed length defined in the field **"Num Bytes to Send"**;
- In the field **"TimeOut Data RX"** the timeout on the serial reception is defined. If the string is not received in the defined time, the data on Modbus will be put to 0. It is possible to set this field to '0' to disable this function;
- In the field **"Time to Wait in RX"** the timeout on reception on serial frame in milliseconds.



Note:

If Data Bits is set to '7' and Parity is set to 'NONE', the number of Stop Bits will be fixed to '2'. In all others cases, the number of Stop Bits is fixed to '1'.

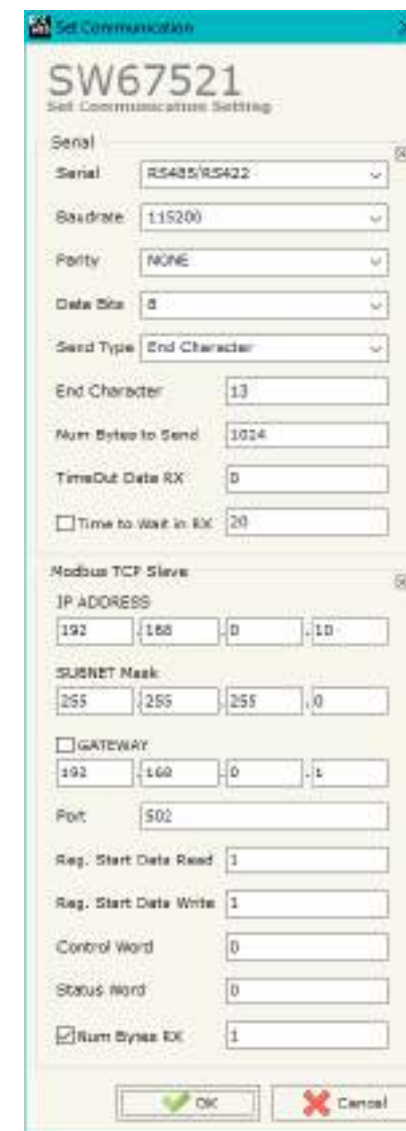

Figure 3: "Set Communication" window

The means for the fields for the "Modbus TCP Slave" are:

- In the field "**IP ADDRESS**" the IP address of Modbus TCP side is defined;
- In the field "**SUBNET Mask**" the SubNet Mask of Modbus TCP side is defined;
- In the field "**GATEWAY**" the default gateway of the net is defined. This feature can be enabled or disabled pressing the Check Box field. This feature is used for going out of the net.
- In the field "**Port**" the TCP port for Modbus TCP communication is defined;
- In the field "**Reg. Start Data Read**" the starting Modbus register from which saving the serial strings received is defined;
- In the field "**Reg. Start Data Write**" the starting Modbus register from which taking data to send on serial side is defined;
- In the field "**Control Word**" the Modbus register for the management of the serial transmission (if option "Send on Control Word" is checked) is defined;
- In the field "**Status Word**" the Modbus register for the management of the serial reception is defined. This register will increase its value when a new serial string is received;
- If the field "**Num Bytes RX**" is checked, the Modbus register where saving the number of bytes received from serial side is defined.

UPDATE DEVICE:

By pressing the **"Update Device"** button, it is possible to load the created Configuration into the device; and also the Firmware, if necessary.

If you don't know the actual IP address of the device you have to use this procedure:

- Turn OFF the Device;
- Put Dip1 of 'Dip-Switch A' in ON position;
- Turn ON the device
- Connect the Ethernet cable;
- Insert the IP **"192.168.2.205"**;
- Select which operations you want to do;
- Press the **"Execute update firmware"** button to start the upload;
- When all the operations are "OK" turn OFF the Device;
- Put Dip1 of 'Dip-Switch A' in OFF position;
- Turn ON the device.

If you know the actual IP address of the device, you have to use this procedure:

- Turn ON the Device with the Ethernet cable inserted;
- Insert the actual IP of the Converter;
- Select which operations you want to do;
- Press the **"Execute update firmware"** button to start the upload;
- When all the operations are "OK" the device automatically goes at Normal Mode.

At this point the configuration/firmware on the device is correctly updated.

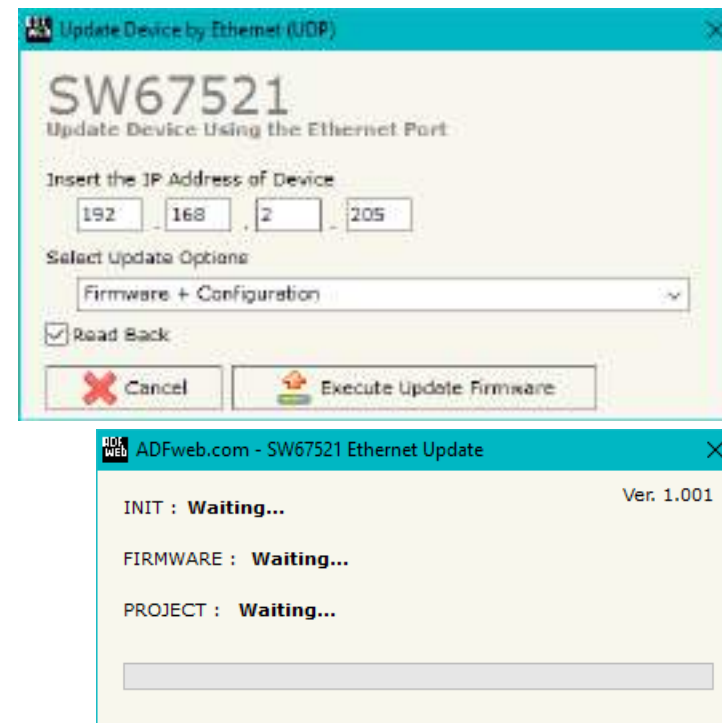

Figure 4: "Update Device" windows

**Note:**

When you receive the device, for the first time, you also have to update the Firmware in the HD67521 device.

**Warning:**

If Fig. 5 appears when you try to do the Update try these points before seeking assistance:

- Try to repeat the operations for the updating;
- Try with another PC;
- Try to restart the PC;
- Check the LAN settings;
- If you are using the program inside a Virtual Machine, try to use in the main Operating System;
- If you are using Windows Seven, Vista, 8, 10 or 11 make sure that you have the administrator privileges;
- In case you have to program more than one device, using the "UDP Update", you have to cancel the ARP table every time you connect a new device on Ethernet. For do this you have to launch the "Command Prompt" and write the command "arp - d". Pay attention that with Windows Vista, Seven, 8, 10 or 11 you have to launch the "Command Prompt" with Administrator Rights;
- Pay attention at Firewall lock.

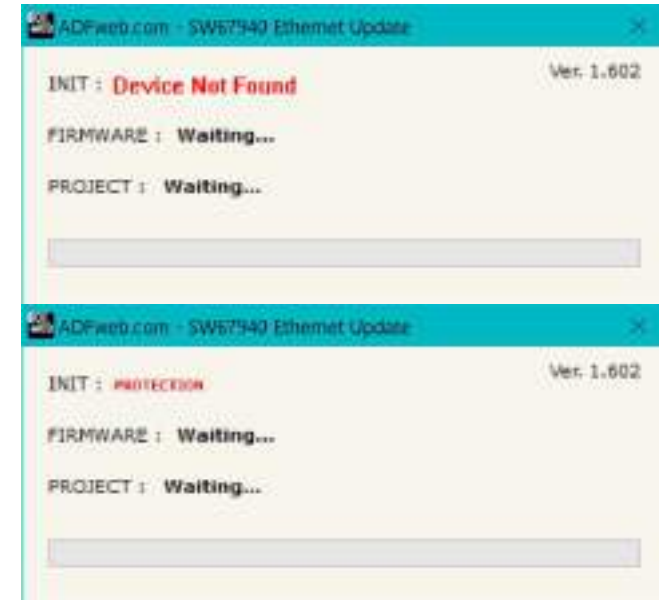

Figure 5: "Error" window

**Warning:**

In the case of HD67521 you have to use the software "SW67521": www.adfweb.com/download/filefold/SW67521.zip.

MECHANICAL DIMENSIONS:

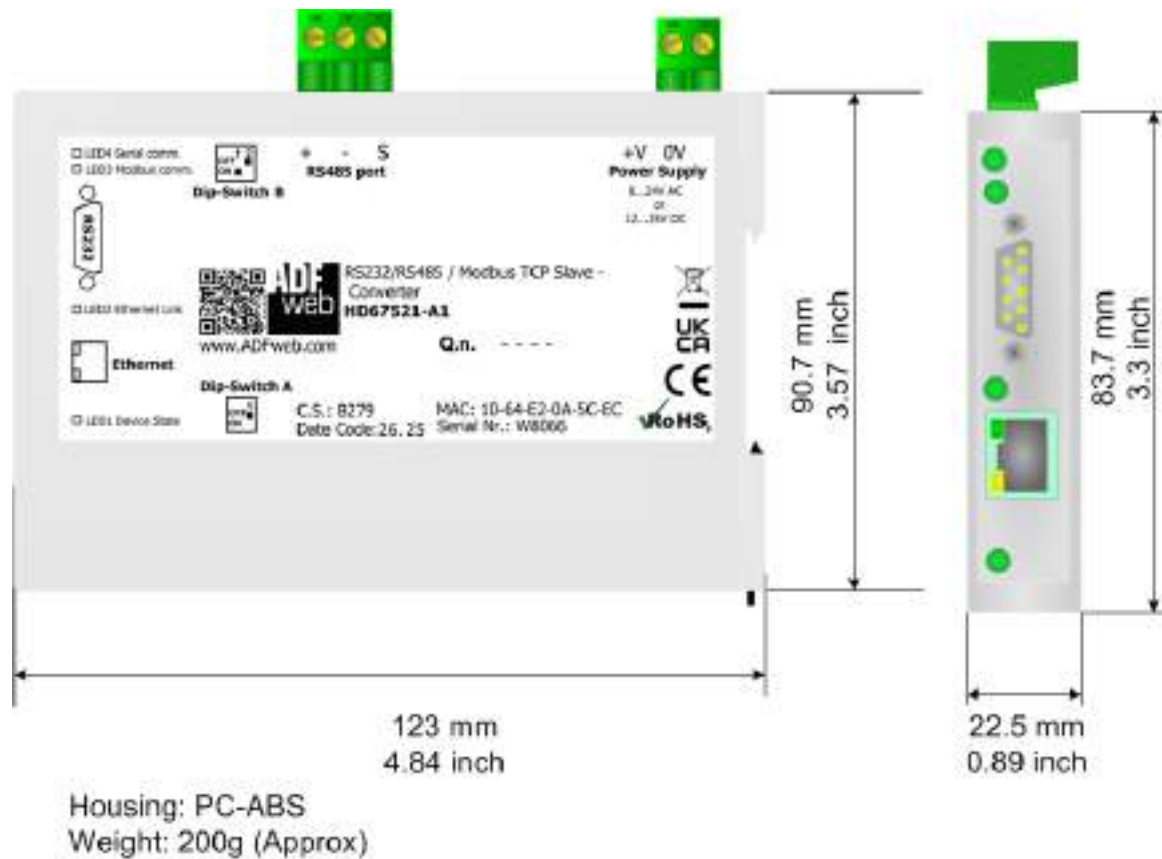

Figure 6a: Mechanical dimensions scheme for HD67521-A1

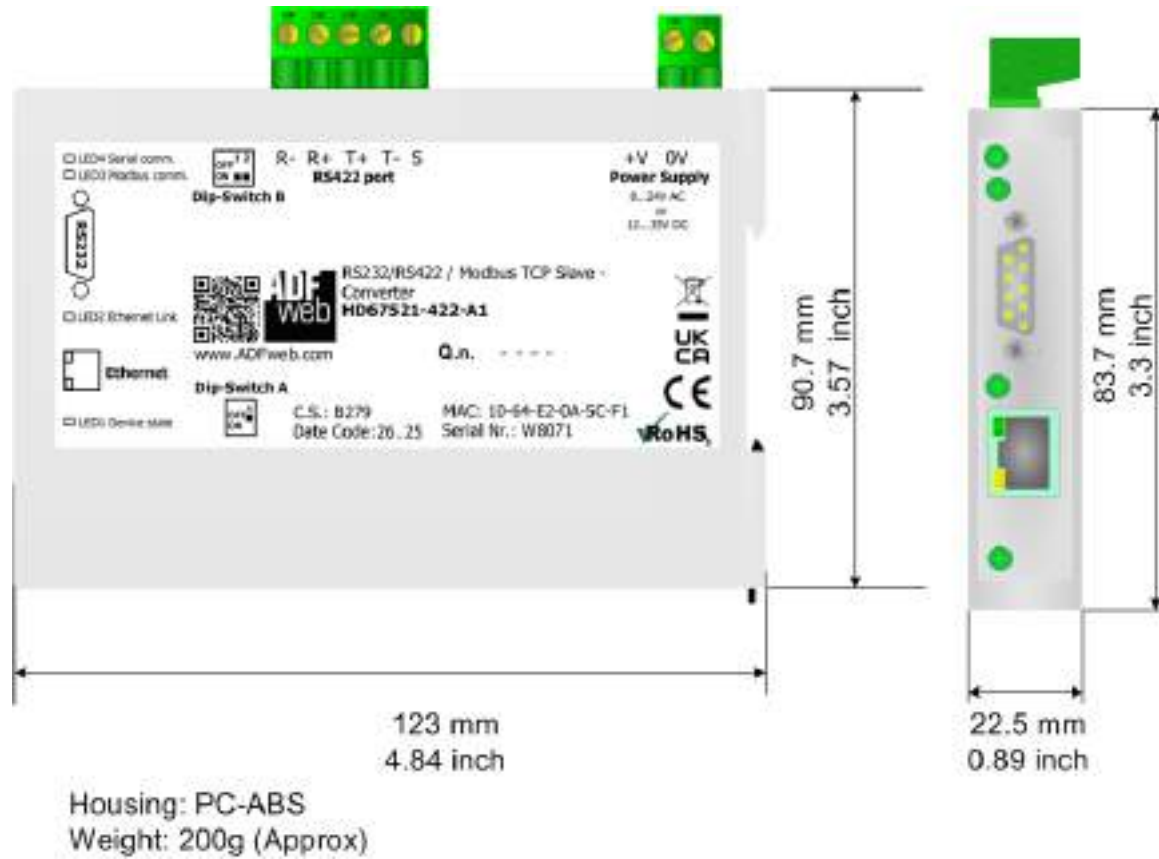
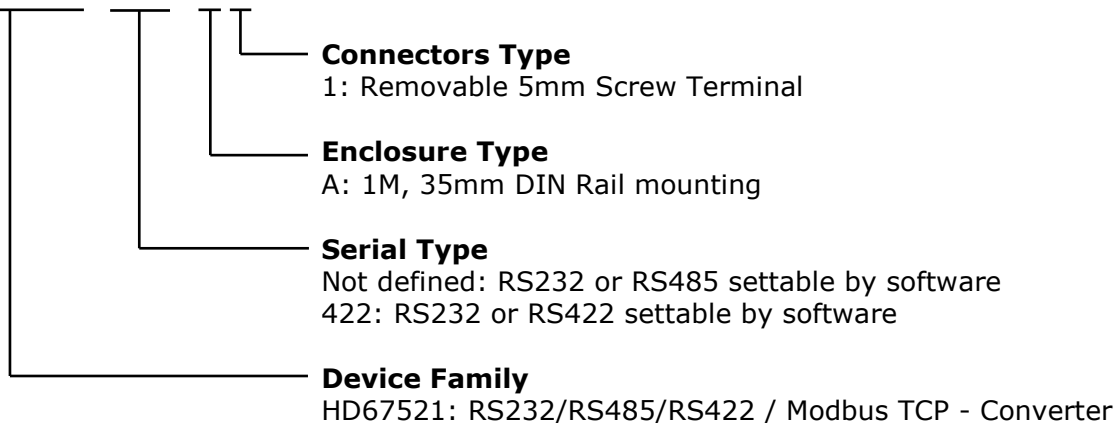

Figure 6b: Mechanical dimensions scheme for HD67521-422-A1

ORDERING INFORMATIONS:

The ordering part number is formed by a valid combination of the following:

HD67521 - xxx - A 1



Order Code: **HD67521-A1** - RS232/RS485 / Modbus TCP – Converter

Order Code: **HD67521-422-A1** - RS232/RS422 / Modbus TCP - Converter

ACCESSORIES:

Order Code: **AC34107** - Null Modem Cable Fem/Fem DSub 9 Pin 1,5 m

Order Code: **AC34114** - Null Modem Cable Fem/Fem DSub 9 Pin 5 m

Order Code: **AC34011** - Rail DIN - Power Supply 220/240V AC 50/60Hz – 12 V DC

Order Code: **AC34012** - Rail DIN - Power Supply 220/240V AC 50/60Hz – 24 V DC

DISCLAIMER:

All technical content within this document can be modified without notice. The content of the document is a under continual renewal. For losses due to fire, earthquake, third party access or other accidents, or intentional or accidental abuse, misuse, or use under abnormal conditions repairs are charged to the user. ADFweb.com S.r.l. will not be liable for accidental loss of use or inability to use this product, such as loss of business income. ADFweb.com S.r.l. shall not be liable for consequences of improper use.

OTHER REGULATIONS AND STANDARDS:**WEEE INFORMATION**

Disposal of old electrical and electronic equipment (as in the European Union and other European countries with separate collection systems).

This symbol on the product or on its packaging indicates that this product may not be treated as household rubbish. Instead, it should be taken to an applicable collection point for the recycling of electrical and electronic equipment. If the product is disposed correctly, you will help prevent potential negative environmental factors and impact of human health, which could otherwise be caused by inappropriate disposal. The recycling of materials will help to conserve natural resources. For more information about recycling this product, please contact your local city office, your household waste disposal service or the shop where you purchased the product.

RESTRICTION OF HAZARDOUS SUBSTANCES DIRECTIVE

The device respects the 2002/95/EC Directive on the restriction of the use of certain hazardous substances in electrical and electronic equipment (commonly referred to as Restriction of Hazardous Substances Directive or RoHS).

CE MARKING

The product conforms with the essential requirements of the applicable EC directives.

WARRANTIES AND TECHNICAL SUPPORT:

For fast and easy technical support for your ADFweb.com SRL products, consult our internet support at www.adfweb.com. Otherwise contact us at the address support@adfweb.com

RETURN POLICY:

If while using your product you have any problem and you wish to exchange or repair it, please do the following:

- Obtain a Product Return Number (PRN) from our internet support at www.adfweb.com. Together with the request, you need to provide detailed information about the problem.
- Send the product to the address provided with the PRN, having prepaid the shipping costs (shipment costs billed to us will not be accepted).

If the product is within the warranty of twelve months, it will be repaired or exchanged and returned within three weeks. If the product is no longer under warranty, you will receive a repair estimate.



ADFweb.com S.r.l.
Via Strada Nuova, 17
IT-31010 Mareno di Piave
TREVISO (Italy)
Phone +39.0438.30.91.31
Fax +39.0438.49.20.99
www.adfweb.com

