

User Manual

Revision 1.001
English

BACnet Slave / SNMP Manager - Converter

(Order Code: HD67170-IP-A1, HD67170-MSTP-A1,
HD67170-MSTP-B2)

For Website information:

www.adfweb.com?Product=HD67170

For Price information:

www.adfweb.com?Price=HD67170-IP-A1

www.adfweb.com?Price=HD67170-MSTP-A1

www.adfweb.com?Price=HD67170-MSTP-B2

Benefits and Main Features:

- ✦ Electrical isolation
- ✦ Temperature range: -40°C/+85°C (-40°F/+185°F)



User Manual

For others SNMP Manager products, see also the following links:

Converter SNMP Manager to

www.adfweb.com?Product=HD67171
www.adfweb.com?Product=HD67172
www.adfweb.com?Product=HD67173
www.adfweb.com?Product=HD67174
www.adfweb.com?Product=HD67175
www.adfweb.com?Product=HD67176
www.adfweb.com?Product=HD67177
www.adfweb.com?Product=HD67178

(CAN)
(CANopen)
(DeviceNet Slave)
(EtherNet/IP)
(Modbus Slave)
(Modbus TCP Slave)
(PROFIBUS Slave)
(PROFINET)

Do you have an your customer protocol?

www.adfweb.com?Product=HD67003

Do you need to choose a device? do you want help?

www.adfweb.com?Cmd=helpme

INDEX:

	Page
INDEX	2
UPDATED DOCUMENTATION	2
REVISION LIST	2
WARNING	2
TRADEMARKS	2
SECURITY ALERT	3
EXAMPLE OF CONNECTION	4
CONNECTION SCHEME	6
CHARACTERISTICS	9
CONFIGURATION	9
POWER SUPPLY	10
FUNCTION MODES	11
LEDS	12
ETHERNET	14
RS485	15
USE OF COMPOSITOR SW67170	16
NEW CONFIGURATION / OPEN CONFIGURATION	17
SOFTWARE OPTIONS	18
SET COMMUNICATION	19
SET BACNET ACCESS	21
SNMP MANAGER	23
UPDATE DEVICE	25
MECHANICAL DIMENSIONS	27
ORDERING INFORMATIONS	30
ACCESSORIES	30
DISCLAIMER	31
OTHER REGULATIONS AND STANDARDS	31
WARRANTIES AND TECHNICAL SUPPORT	32
RETURN POLICY	32

UPDATED DOCUMENTATION:

Dear customer, we thank you for your attention and we remind you that you need to check that the following document is:

- ✚ Updated
- ✚ Related to the product you own

To obtain the most recently updated document, note the “document code” that appears at the top right-hand corner of each page of this document.

With this “Document Code” go to web page www.adfweb.com/download/ and search for the corresponding code on the page. Click on the proper “Document Code” and download the updates.

REVISION LIST:

Revision	Date	Author	Chapter	Description
1.000	09/10/2015	Ff	All	First Release
1.001	09/07/2025	Mdb	All	New design

WARNING:

ADFweb.com reserves the right to change information in this manual about our product without warning. ADFweb.com is not responsible for any error this manual may contain.

TRADEMARKS:

All trademarks mentioned in this document belong to their respective owners.

SECURITY ALERT:**GENERAL INFORMATION**

To ensure safe operation, the device must be operated according to the instructions in the manual. When using the device, legal and safety regulation are required for each individual application. The same applies also when using accessories.

INTENDED USE

Machines and systems must be designed so the faulty conditions do not lead to a dangerous situation for the operator (i.e. independent limit switches, mechanical interlocks, etc.).

QUALIFIED PERSONNEL

The device can be used only by qualified personnel, strictly in accordance with the specifications.

Qualified personnel are persons who are familiar with the installation, assembly, commissioning and operation of this equipment and who have appropriate qualifications for their job.

RESIDUAL RISKS

The device is state-of-the-art and is safe. The instruments can represent a potential hazard if they are inappropriately installed and operated by untrained personnel. These instructions refer to residual risks with the following symbol:



This symbol indicates that non-observance of the safety instructions is a danger for people that could lead to serious injury or death and / or the possibility of damage.

CE CONFORMITY

The declaration is made by our company. You can send an email to support@adfweb.com or give us a call if you need it.

EXAMPLE OF CONNECTION:

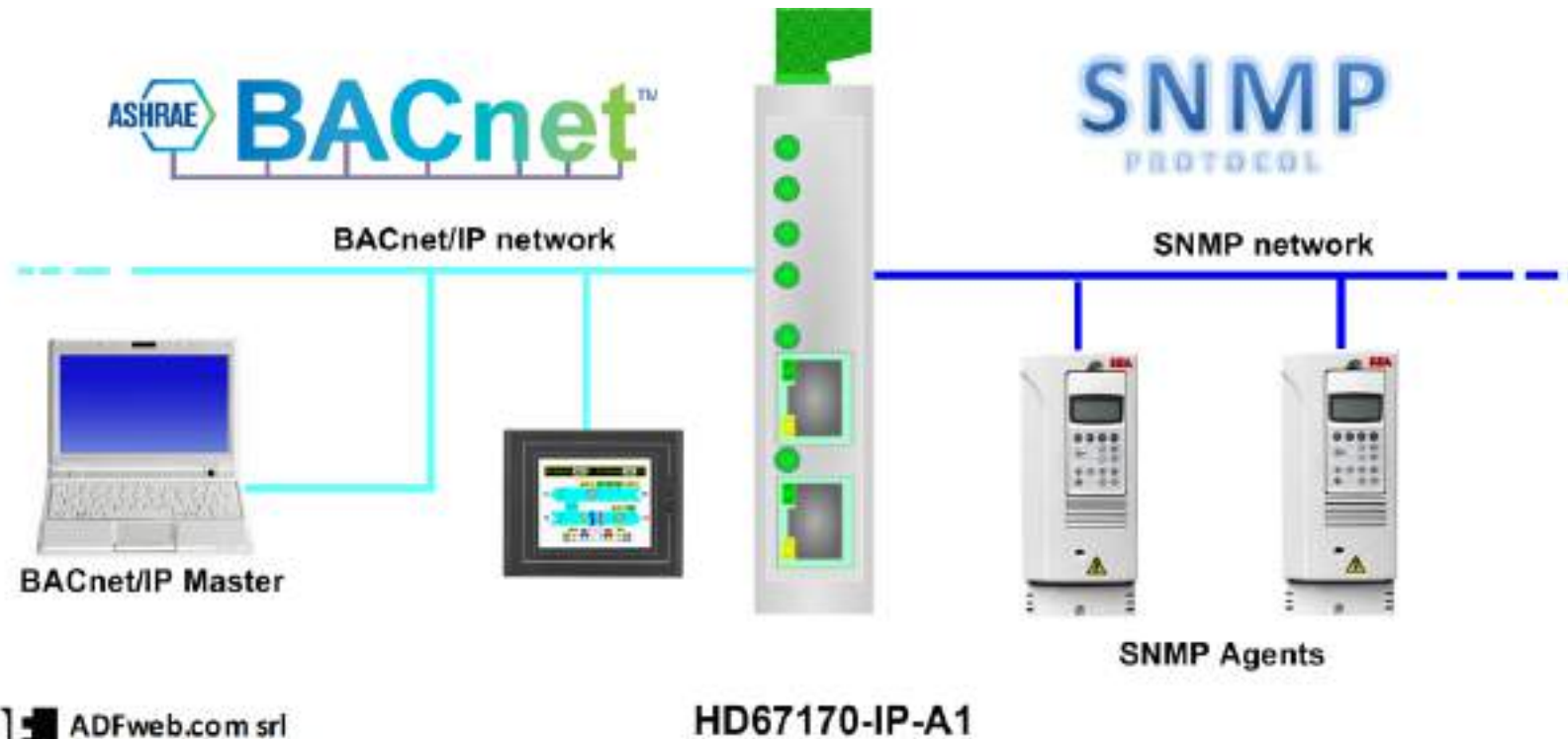

 ADFweb.com srl
tel. +39 - 0438.30.91.31
www.adfweb.com
info@adfweb.com

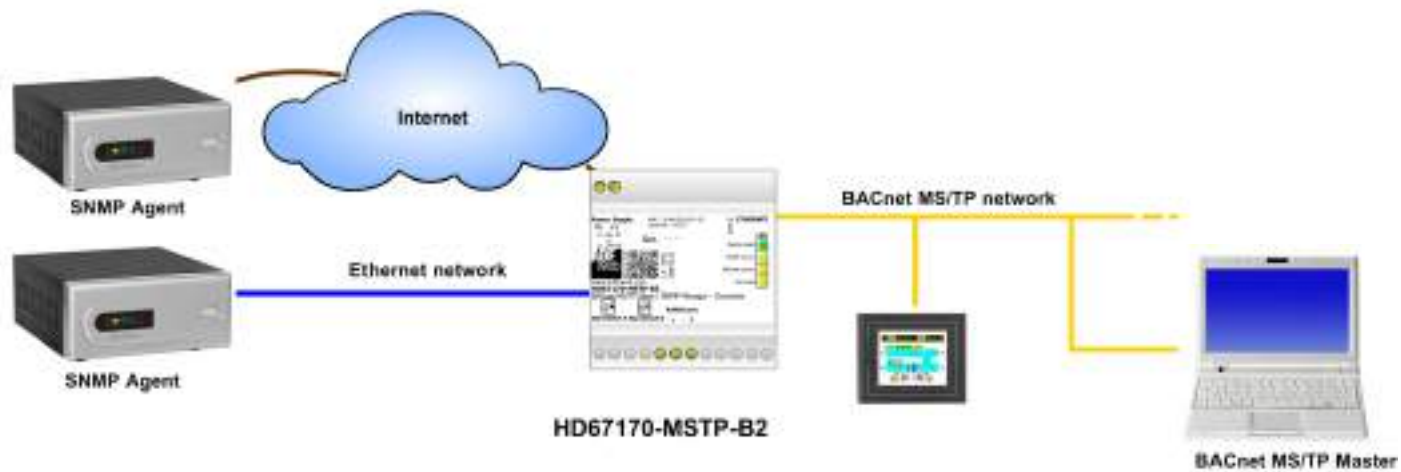
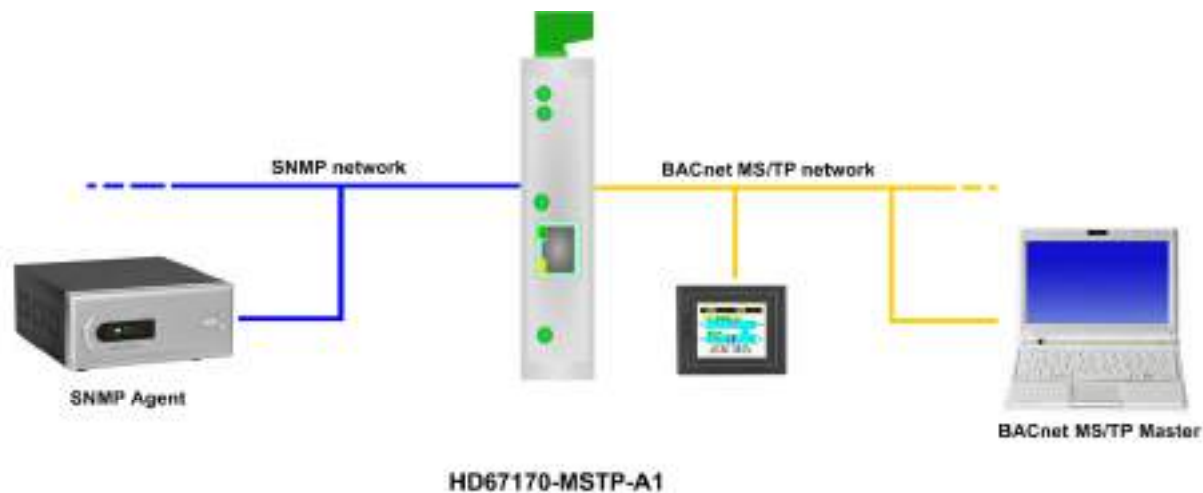

CONNECTION SCHEME:

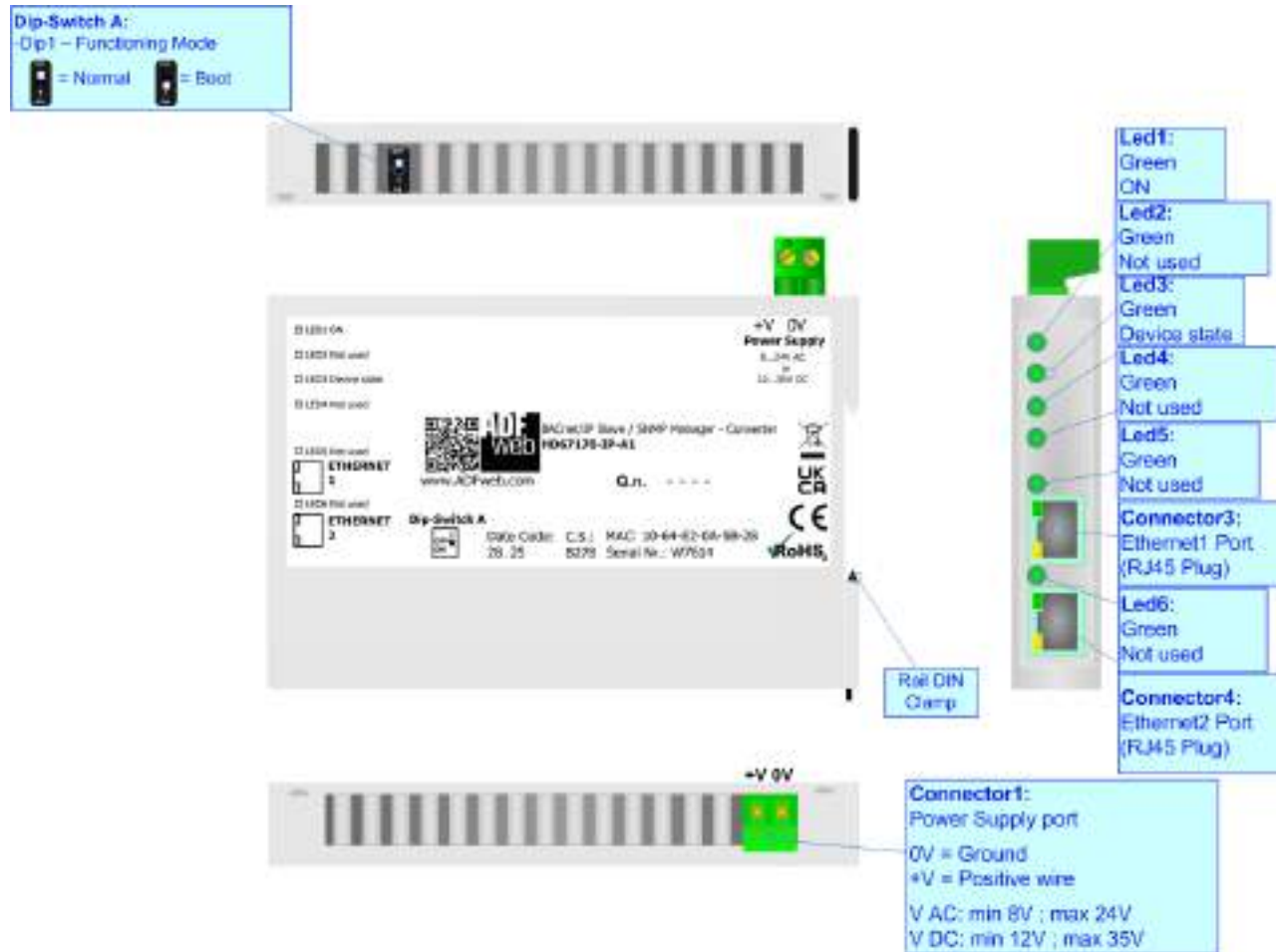

Figure 1a: Connection scheme for HD67170-IP-A1

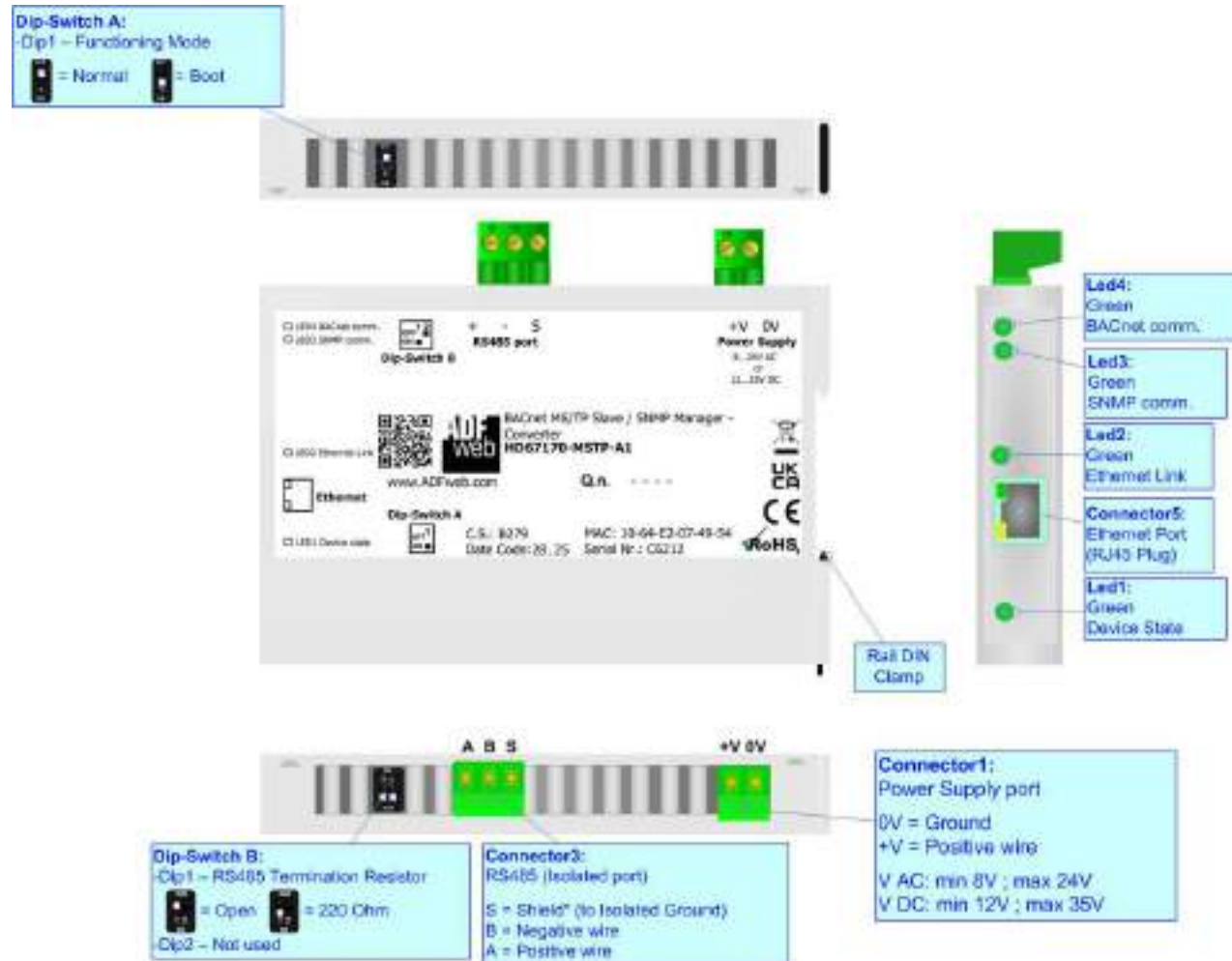

Figure 1b: Connection scheme for HD67170-MSTP-A1

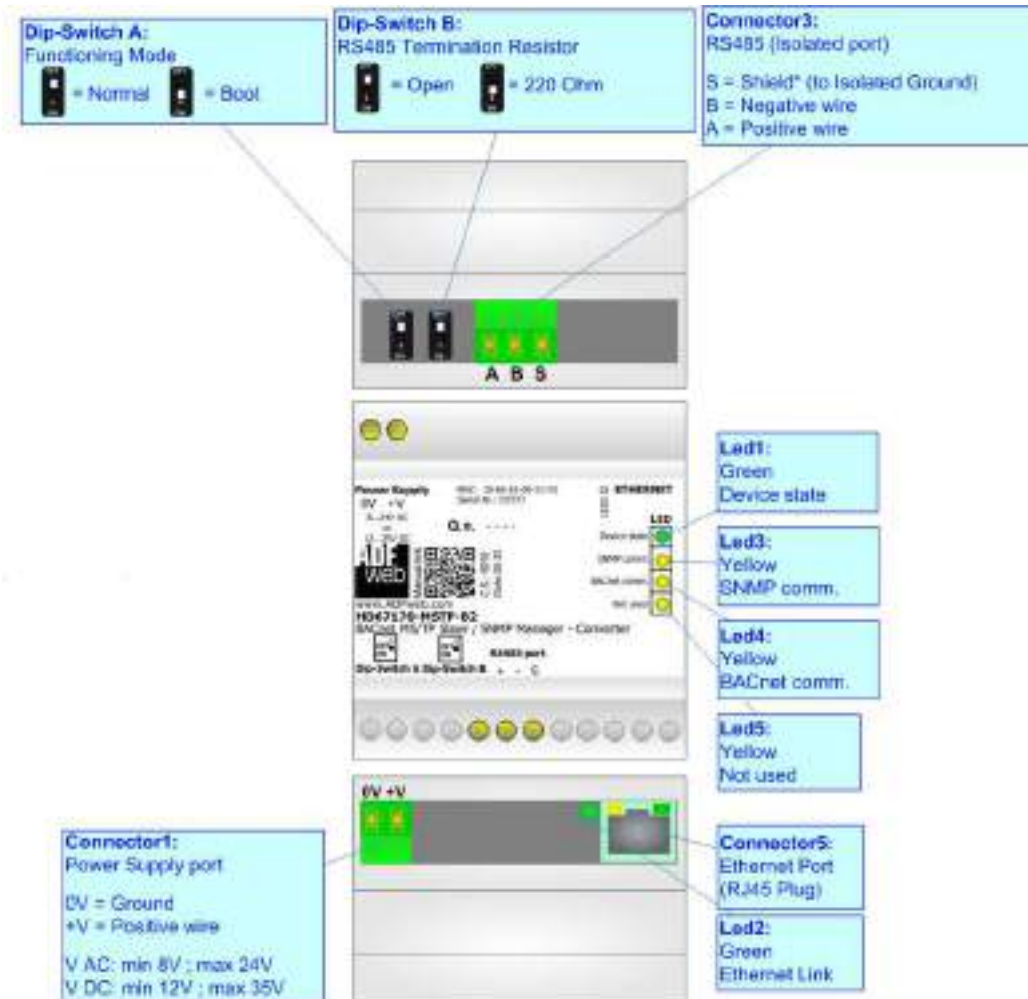

Figure 1c: Connection scheme for HD67170-MSTP-B2

CHARACTERISTICS:

The HD67170 is a BACnet Slave / SNMP Manager - Converter.

It has the following characteristics:

- Up to 1440 bytes in reading and 1440 bytes in writing;
- Isolation between Power Supply – Ethernet, Ethernet – Serial, Power Supply - Serial.
- Two-directional information between BACnet bus and SNMP bus;
- Mountable on 35mm Rail DIN;
- Wide power supply input range: 8...24V AC or 12...35V DC;
- Wide temperature range: -40°C / +85°C [-40°F / +185°F].

CONFIGURATION:

You need Compositor SW67170 software on your PC in order to perform the following:

- Define the parameter of SNMP line;
- Define the parameter of BACnet line;
- Define the SNMP requests to send to the SNMP Agents;
- Define the BACnet Objects in reading and in writing;
- Update the device.

POWER SUPPLY:

The devices can be powered at 8...24V AC and 12...35V DC. For more details see the two tables below.

VAC		VDC	
Vmin	Vmax	Vmin	Vmax
8V	24V	12V	35V

Consumption at 24V DC:

Device	Consumption [W/VA]
HD67170-IP-A1	3.5
HD67170-MSTP-A1	3.5
HD67170-MSTP-B2	3.5

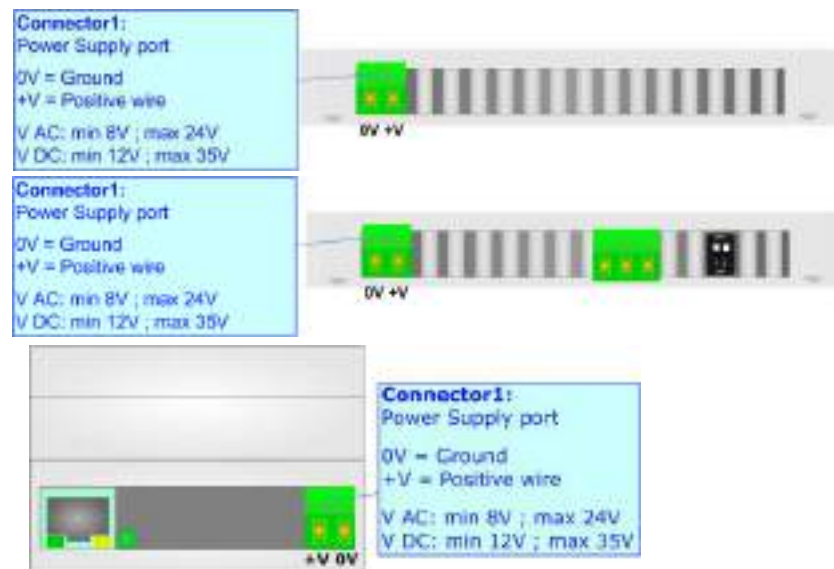

Caution: Not reverse the polarity power



HD67170-IP-A1
HD67170-MSTP-A1

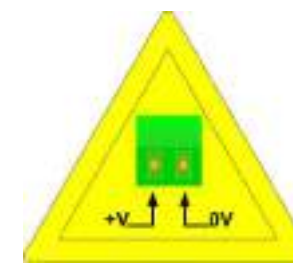

HD67170-MSTP-B2

FUNCTION MODES:

The device has got two functions mode depending of the position of the 'Dip1 of Dip-Switch A':

- The first, with 'Dip1 of Dip-Switch A' at "OFF" position, is used for the normal working of the device.
- The second, with 'Dip1 of Dip-Switch A' at "ON" position, is used for upload the Project and/or Firmware.

For the operations to follow for the updating, see 'UPDATE DEVICE' section.

According to the functioning mode, the LEDs will have specifics functions, see 'LEDS' section.

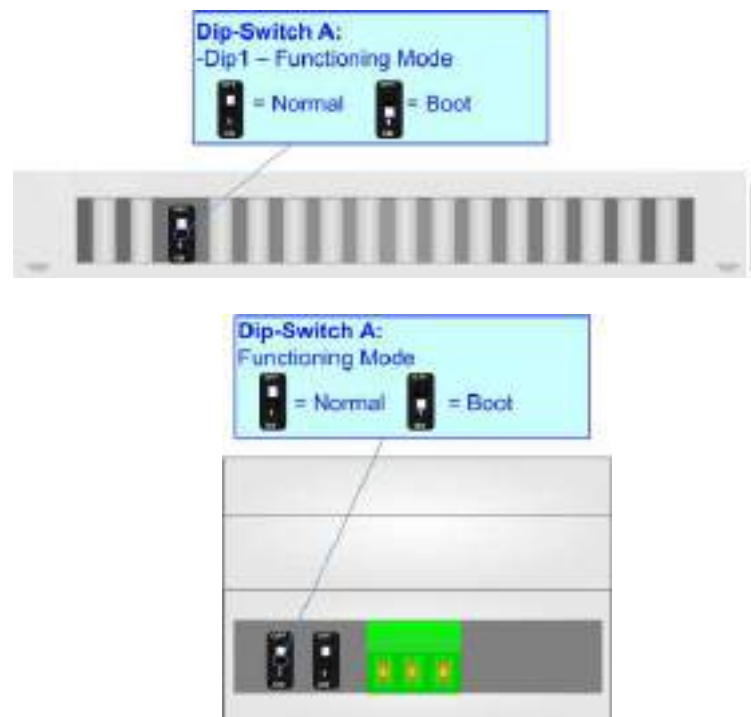

LEDS (HD67170-IP-A1):

The device has got six LEDs that are used to give information about the functioning status.
The various meanings of the LEDs are described in the table below.

LED	Normal Mode	Boot Mode
1: ON [supply voltage] (green)	ON: Device powered OFF: Device not powered	ON: Device powered OFF: Device not powered
2: Not used (green)	OFF	Blinks quickly: Boot state Blinks very slowly (~0.5Hz): update in progress
3: Device state (green)	Blinks slowly (~1Hz)	Blinks quickly: Boot state Blinks very slowly (~0.5Hz): update in progress
4: Not used (green)	OFF	Blinks quickly: Boot state Blinks very slowly (~0.5Hz): update in progress
5: Not used (green)	OFF	Blinks quickly: Boot state Blinks very slowly (~0.5Hz): update in progress
6: Not used (green)	OFF	Blinks quickly: Boot state Blinks very slowly (~0.5Hz): update in progress



LEDS (HD67170-MSTP-A1/B2):

The devices have got four (five for HD67170-MSTP-B2) LEDs that are used to give information of the functioning status. The various meanings of the LEDs are described in the table below.

LED	Normal Mode	Boot Mode
1: Device state (green)	Blinks slowly (~1Hz)	Blinks quickly: Boot state Blinks very slowly (~0.5Hz): update in progress
2: Ethernet Link (green)	ON: Ethernet cable connected OFF: Ethernet cable disconnected	ON: Ethernet cable connected OFF: Ethernet cable disconnected
3: SNMP comm. (green)	Blinks when a SNMP response is received	Blinks quickly: Boot state Blinks very slowly (~0.5Hz): update in progress
4: BACnet comm. (green)	Blinks when BACnet request is received	Blinks quickly: Boot state Blinks very slowly (~0.5Hz): update in progress
5: Not used (yellow) (Present only on HD67170-MSTP-B2)	OFF	Blinks quickly: Boot state Blinks very slowly (~0.5Hz): update in progress

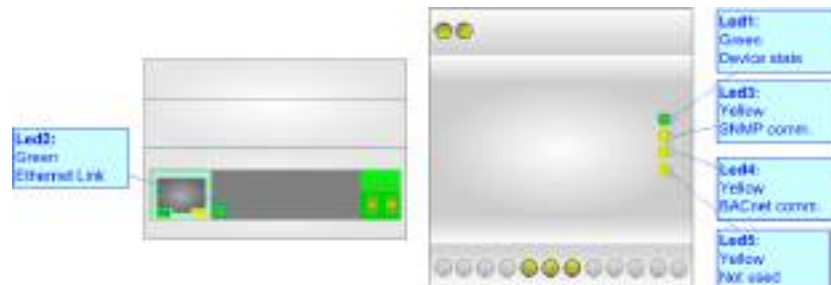
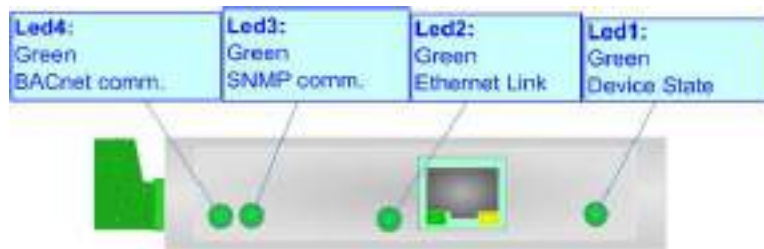

ETHERNET:

The SNMP, BACnet/IP connection and the updating of the converter must be made using Connector3 or Connector4 or Connector5 of HD67170 with at least a Category 5E cable. The maximum length of the cable should not exceed 100m. The cable has to conform to the T568 norms relative to connections in cat.5 up to 100 Mbps. To connect the device to an Hub/Switch is recommended the use of a straight cable, to connect the device to a PC/other is recommended the use of a cross cable.

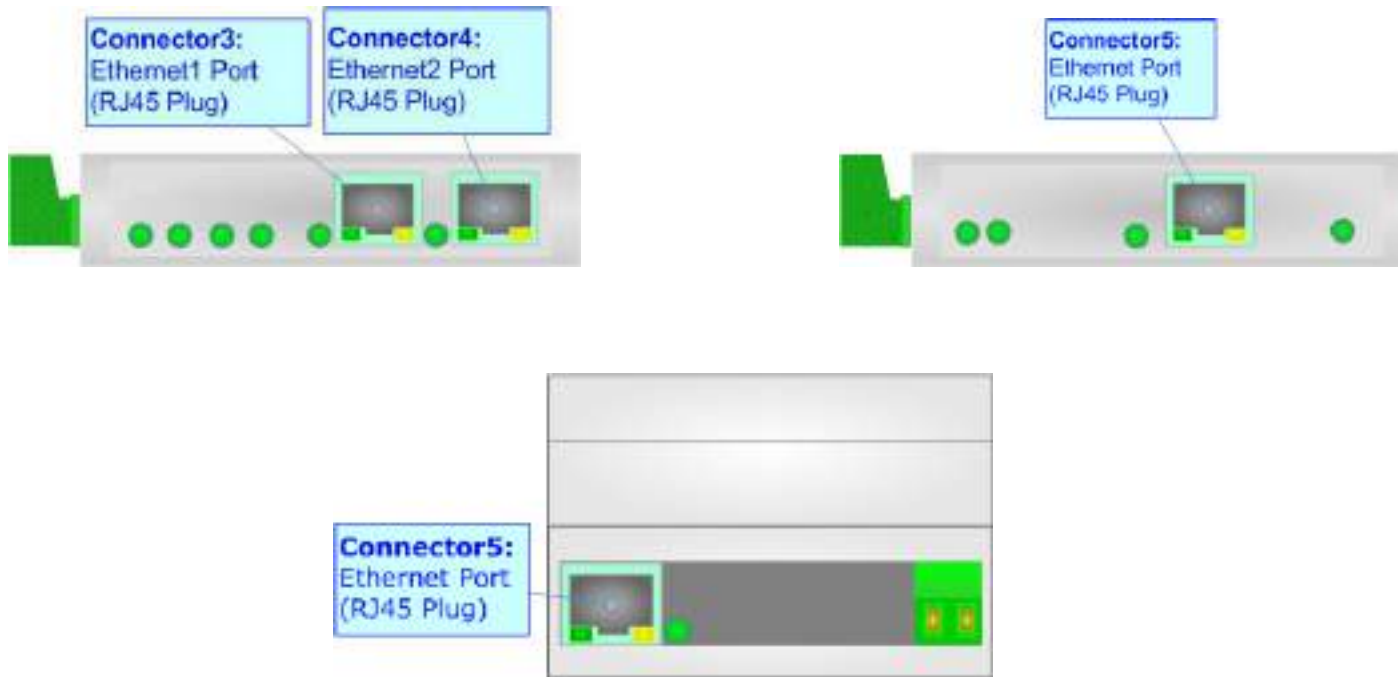

RS485 (for HD67170-MSTP-A1/B2):

For terminate the RS485 line with a 220Ω resistor it is necessary to put ON dip 1, like in figure.

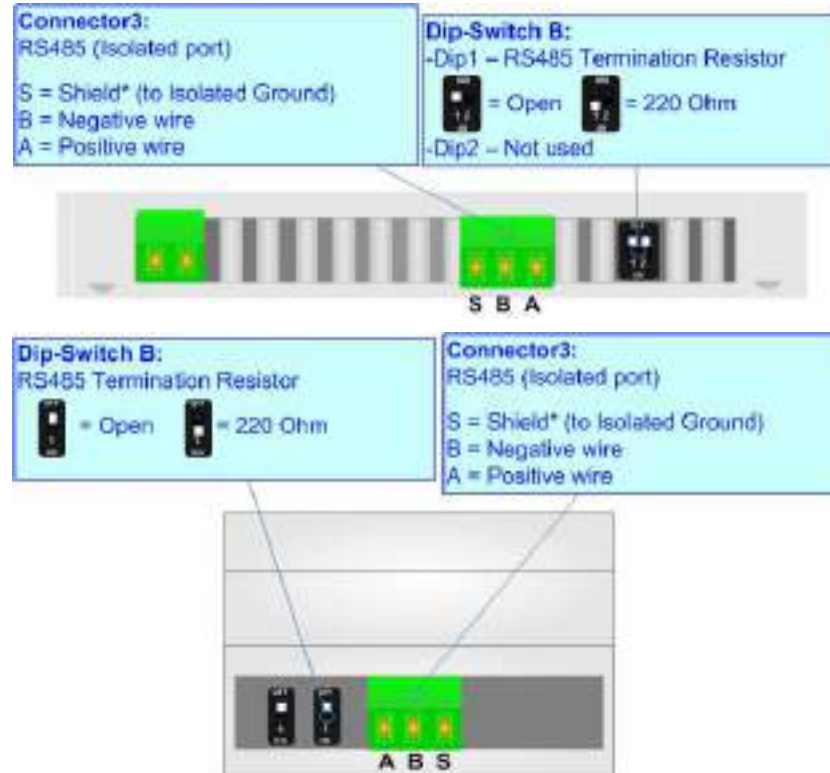

The maximum length of the cable should be 1200m (4000 feet).

Here some codes of cables:

- Belden: p/n 8132 - 2x 28AWG stranded twisted pairs conductor + foil shield + braid shield;
- Belden p/n 82842 - 2x 24AWG stranded twisted pairs conductor + foil shield + braid shield;
- Tasker: p/n C521 - 1x 24AWG twisted pair conductor + foil shield + braid shield;
- Tasker: p/n C522 - 2x 24AWG twisted pairs conductor + foil shield + braid shield.

USE OF COMPOSITOR SW67170:

To configure the Converter, use the available software that runs with Windows called SW67170. It is downloadable on the site www.adfweb.com and its operation is described in this document. *(This manual is referenced to the last version of the software present on our web site).* The software works with MSWindows (XP, Vista, Seven, 8, 10 or 11; 32/64bit).

When launching the SW67170, the window below appears (Fig. 2).



Note:

It is necessary to have installed .Net Framework 4.



Figure 2: Main window for SW67170

NEW CONFIGURATION / OPEN CONFIGURATION:

The “**New Configuration**” button creates the folder which contains the entire device’s configuration.



A device’s configuration can also be imported or exported:

- To clone the configurations of a Programmable “BACnet Slave / SNMP Manager - Converter” in order to configure another device in the same manner, it is necessary to maintain the folder and all its contents;
- To clone a project in order to obtain a different version of the project, it is sufficient to duplicate the project folder with another name and open the new folder with the button “**Open Configuration**”.

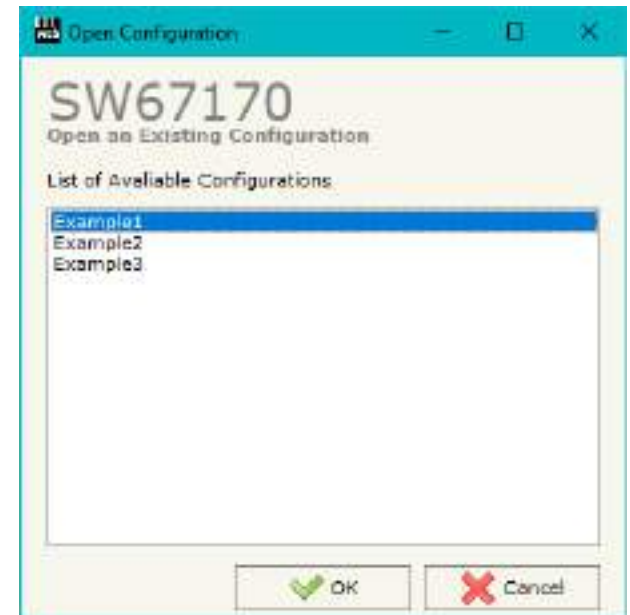

SOFTWARE OPTIONS:

By pressing the “**Settings**” () button there is the possibility to change the language of the software and check the updatings for the compositor.

In the section “Language” it is possible to change the language of the software.



In the section “Connection Options”, it is possible to check if there are some updatings of the software compositor in ADFweb.com website. Checking the option “**Check Software Update at Start of Program**”, the SW67170 check automatically if there are updatings when it is launched.



In the section "Software Settings", it is possible to enable/disable some keyboard's commands for an easier navigation inside the tables contained in the different sections of the software.

SET COMMUNICATION:

This section define the fundamental communication parameters of two buses, BACnet and SNMP.

By Pressing the "**Set Communication**" button from the main window for SW67170 (Fig. 2) the window "Set Communication" appears (Fig. 3).

The window is divided in three sections, one for selecting the type of BACnet (in relation to the device bought), one for the BACnet parameters and the other for the SNMP parameters.

In the section "BACnet Type" is possible to select the type of BACnet to use from:

- BACnet/IP (uses ethernet);
- BACnet MS/TP (uses RS485);

If selected "BACnet/IP" the means of the fields for "BACnet" are:

- In the fields "**IP ADDRESS**" insert the IP address that you want to give to the Converter;
- In the fields "**SUBNET Mask**" insert the SubNet Mask;
- In the fields "**GATEWAY**" insert the default gateway that you want to use. This feature can be enabled or disabled pressing the Check Box field. This feature is used for going out of the net;
- In the field "**Port**" the port used for BACnet communication is defined. The default port used for BACnet communication is 47808, but is possible to insert any value (except 10000 and 10001);
- In the field "**BACnet Device Name**" is possible to assign a name to the BACnet node;
- In the field "**Device Identifier**" is possible to assign a number to the BACnet node (used for the Device Identifier);
- If the field "**BACnet description up to 32 chars**" is checked, the description of the BACnet objects can be up to 32 chars;
- If the field "**Enable BBMD**" is checked, the BACnet/IP Broadcast Management Device function is enabled;
- If the field "**Accept FDR**" is checked, the converter accepts the Foreign Device Registration.

The means of the fields for "SNMP Manager" are:

- In the field "**IP ADDRESS**" insert the IP address that you want to give to the SNMP side;
- In the field "**SUBNET Mask**" insert the SubNet Mask of the SNMP side;

The screenshot shows the 'Set Communication' window for device SW67170. The window is titled 'Set Communication' and has a close button in the top right corner. The main title is 'SW67170' and the subtitle is 'Set Communication Setting'. The window is divided into three main sections: 'BACnet Type', 'BACnet', and 'SNMP Manager'.
1. 'BACnet Type' section: A dropdown menu is set to 'BACnet/IP'.
2. 'BACnet' section: Contains fields for 'IP ADDRESS' (192, 168, 0, 5), 'SUBNET Mask' (255, 255, 255, 0), a 'GATEWAY' checkbox (unchecked), 'Port' (47808), 'BACnet Device Name' (devicename1), and 'Device Identifier' (1). There are also three unchecked checkboxes: 'BACnet description up to 32 chars', 'Enable BBMD', and 'Accept FDR'.
3. 'SNMP Manager' section: Contains fields for 'IP ADDRESS' (192, 168, 0, 10) and 'SUBNET Mask' (255, 255, 255, 0). It also has a 'GATEWAY' checkbox (unchecked).
At the bottom of the window, there are two buttons: 'OK' with a green checkmark and 'Cancel' with a red X.

Figure 3a: "Set Communication" window

- In the field "**GATEWAY**" insert the default gateway that you want to use. This feature can be enabled or disabled pressing the Check Box field. This feature is used for going out of the net;

If selected "BACnet MS/TP" the means of the fields for "BACnet" are:

- In the field "**Baudrate**" it is possible to select the baudrate of the BACnet line (1200, 2400, 4800, 9600, 19200, 38400, 57600, 115200);
- In the field "**Parity**" it is possible to select the parity of the line (None, Odd, Even);
- In the field "**BACnet Device Name**" is possible to insert the name to give to the BACnet node (maximum 17 characters);
- In the field "**MAC Address**" is possible to define the MAC of BACnet node (from 0 to 254);
- The field "**Max Masters**" specifies the highest allowable address for master nodes. The value shall be less than or equal to 127;
- The field "**Max Info Frames**" specifies the maximum number of information frames the node may send before it must pass the token;
- In the field "**Device Instance**" it is possible to assign a number to the BACnet node;
- In the field "**Network**" it is possible to define the number of the BACnet MS/TP network;
- If the field "**BACnet description up to 32 chars**" is checked, the description of the BACnet objects can be up to 32 chars.

The screenshot shows the 'Set Communication' window for device SW67170. The window is titled 'Set Communication' and 'Set Communication Setting'. It contains the following fields and controls:

- BACnet Type:** Type: BACnet MS/TP
- BACnet:** Baudrate: 57600, Parity: NONE
- BACnet Device Name:** devicename1
- MAC Address:** 0
- Max Master:** 1
- Max Info Frames:** 1
- Device Instance:** 1
- Network:** 1
- BACnet description up to 32 chars
- SNMP Manager:** IP ADDRESS: 192.168.0.10, SUBNET Mask: 255.255.255.0, GATEWAY: 192.168.0.1

Buttons: OK, Cancel

Figure 3b: "Set Communication" window

SET BACNET ACCESS:

By Pressing the **“Set BACnet Access”** button from the main window for SW67170 (Fig. 2) the window **“BACnet Set Access”** appears (Fig. 4).

The window is divided in two parts, the **“BACnet in Read”** that contains the BACnet objects readable by a BACnet Master; and **“BACnet in Write”** that contains the BACnet objects writeable by a BACnet Master.

The meaning of the fields in the window are the follows:

- In the field **“Data Type”** is possible to select the BACnet object data type;
- In the field **“Eng. Unit”**, with double click the window **“Select the BACnet Engineering Unit”** appears (Fig. 5);
- In the field **“Position”** is possible to select the position where take/save the data from a 1440 bytes array. This array will be used to link the data from/to SNMP side;
- The field **“Start Bit”** is used for the **“Binary In”** and **“Binary Out”** BACnet objects;
- The field **“Length”** is used for all the others BACnet objects.
- If the field **“SWAP”** is checked, the bytes’ order is reversed;
- In the field **“Mnemonic”** a description of the data inserted in the row is defined.

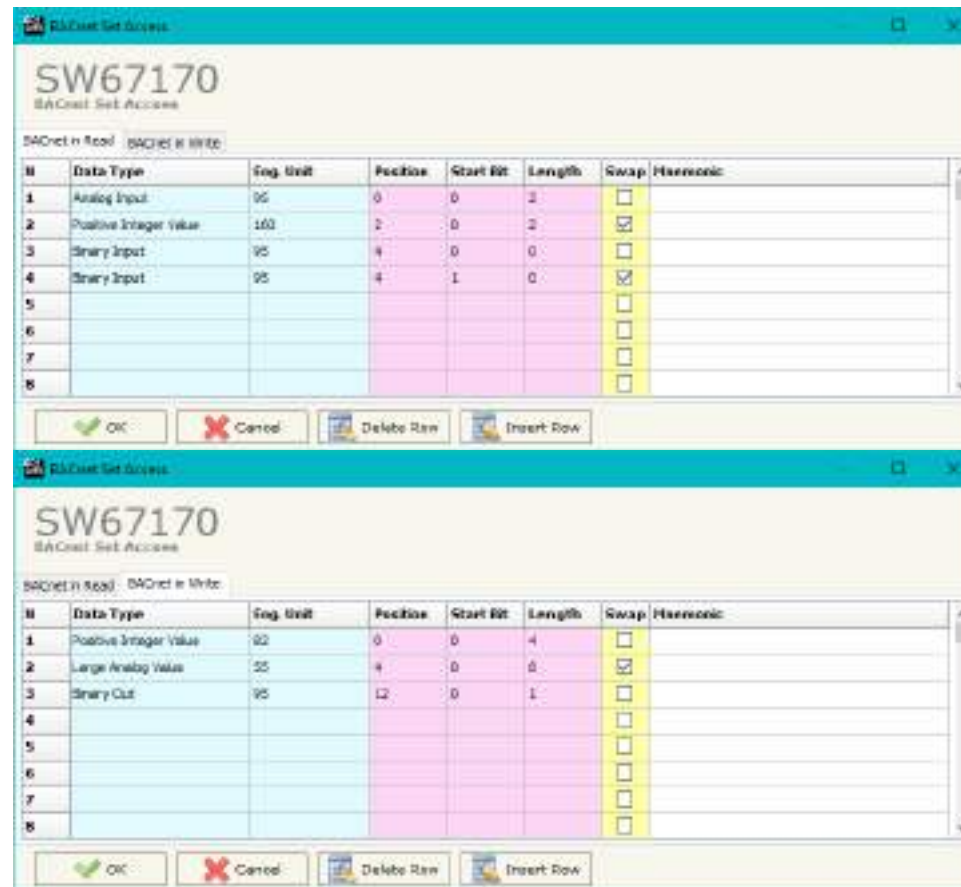

Figure 4: “BACnet Set Access” window

It is possible to insert directly the Unit (using its unique number) by compiling the **"Selected BACnet Engineering Unit"** field; or by selecting with the fields **"Select the Type"** and **"Select unit"** the Type/Unit desired. If the second way is used, is necessary to press the **"Select Engineering Unit"** button for confirm the choice.

Select the BACnet Engineering Unit

SW67170

Select the BACnet Engineering Unit

Selected BACnet Engineering Unit: 166 -> meters-per-second-per-second

Select a New BACnet Engineering Unit

Select the Type: Acceleration

Select Unit: meters-per-second-per-second

Select Engineering Unit

OK Cancel

Figure 5: "Select the BACnet Engineering Unit" window

SET ACCESS:

Figure 6: "Set SNMP Manager Access" window

By Pressing the "SNMP Manager" button from the main window for SW67170 (Fig. 2) the window "Set SNMP Manager Access" appears (Fig. 6).

The meaning of the fields in the window are the follows:

- If the field "Enable" is checked, the SNMP request is enabled;
- In the field "IP Address" the address of the SNMP Agent device that you have to read/write is defined;
- In the field "Version" the SNMP version used to send the SNMP request (1, 2 or 3) is defined;
- In the field "Community Name" the Community Name used for the SNMP request ('Public' or 'Private') is defined;
- In the field "OID" the OID to read/write from/to the SNMP Agent device is defined;
- In the field "Type" the type of data to read/write ('String' or 'Int') is defined;
- In the field "Mode" the type of SNMP request used ('Get', 'Set' or 'Trap') is defined;
- By checking the field "On Change" the SNMP request (only for the 'Set' Mode) is made only if BACnet data written by the BACnet Master are changed;
- By checking the field "On CMD" the SNMP request is sent when the BACnet Object associated to this specific SNMP request is written;
- If the field "On Timer" is checked, the SNMP request is sent cyclically;
- In the field "Time" the delay in ms between two SNMP requests is defined (if "On Timer" is checked);
- In the field "Position" it is possible to select the position where take/save the data from/to the internal SNMP array;
- In the field "Num Bytes" it is possible to select define the dimension of the SNMP Data;

- In the field "**Conversion**" it is possible to select the conversion to apply to the data read/written from/to the SNMP Agent;
- If the field "**Cancel**" is checked, if the answer to the SNMP request is missing, the data on MQTT side are set to '0';
- If SNMP version is set to '3', the following fields must be set:
 - In the field "**User**" the user for the SNMP authentication is defined;
 - In the field "**Auth Pass**" the password for the SNMP authentication is defined;
 - In the field "**Priv Pass**" the password for Privacy authentication is defined;
 - In the field "**Security Level**" the type of security used is defined;
 - In the field "**Auth Mode**" the mode used for the authentication is defined;
 - In the field "**Priv Mode**" the mode used for Privacy is defined;
- In the field "**Mnemonic**" a description of the data inserted in the row is defined.

**Note:**

If the field "On change" and "On Timer" is checked and the "Poll Time" is different from 0, the converter sends the SNMP writing request cyclically and also when the data is changed.

**Note:**

If the "Trap" mode is used, the fields "On CMD", "On Change" and "On Timer" must be disabled.

OBJECTS MAP:

By Pressing the "**Objects Map**" button from the main window for SW67170 (Fig. 2) is possible to create a .csv document with the map of BACnet Objects.

UPDATE DEVICE:

By pressing the **"Update Device"** button, it is possible to load the created Configuration into the device; and also the Firmware, if necessary.

If you don't know the actual IP address of the device you have to use this procedure:

- Turn off the Device;
- Put Dip1 of 'Dip-Switch A' in ON position;
- Turn on the device
- Connect the Ethernet cable;
- Insert the IP **"192.168.2.205"**;
- Press the **"Ping"** button, "Device Found!" must appear;
- Press the **"Next"** button;
- Select which operations you want to do;
- Press the **"Execute update firmware"** button to start the upload;
- When all the operations are "OK" turn off the Device;
- Put Dip1 of 'Dip-Switch A' at OFF position;
- Turn on the device.

At this point the configuration/firmware on the device is correctly updated.

If you know the actual IP address of the device, you have to use this procedure:

- Turn on the Device with the Ethernet cable inserted;
- Insert the actual IP of the Converter;
- Press the **"Ping"** button, must appear "Device Found!";
- Press the **"Next"** button;
- Select which operations you want to do;
- Press the **"Execute update firmware"** button to start the upload;
- When all the operations are "OK" the device automatically goes at Normal Mode.

At this point the configuration/firmware on the device is correctly update.



Figure 7: "Update device" windows

**Note:**

When you receive the device, for the first time, you also have to update the Firmware in the HD67170 device.

**Warning:**

If Fig. 8 appears when you try to do the Update try these points before seeking assistance:

- Check if the serial COM port selected is the correct one;
- Check if the serial cable is connected between the PC and the device;
- Try to repeat the operations for the updating;
- Try with another PC;
- Try to restart the PC;
- Check the LAN settings;
- If you are using the program inside a Virtual Machine, try to use in the main Operating System;
- If you are using Windows Seven, Vista, 8, 10 or 11 make sure that you have the administrator privileges;
- In case you have to program more than one device, using the "UDP Update", you have to cancel the ARP table every time you connect a new device on Ethernet. For do this you have to launch the "Command Prompt" and write the command "arp - d". Pay attention that with Windows Vista, Seven, 8, 10 or 11 you have to launch the "Command Prompt" with Administrator Rights;
- Pay attention at Firewall lock.

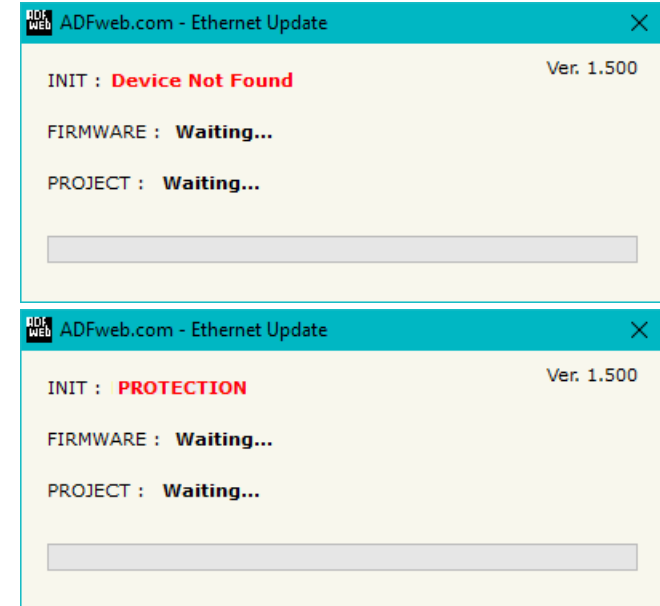

Figure 8: "Error" window

**Warning:**

In the case of HD67170 you have to use the software "HD67170": www.adfweb.com/download/filefold/HD67170.zip.

MECHANICAL DIMENSIONS:

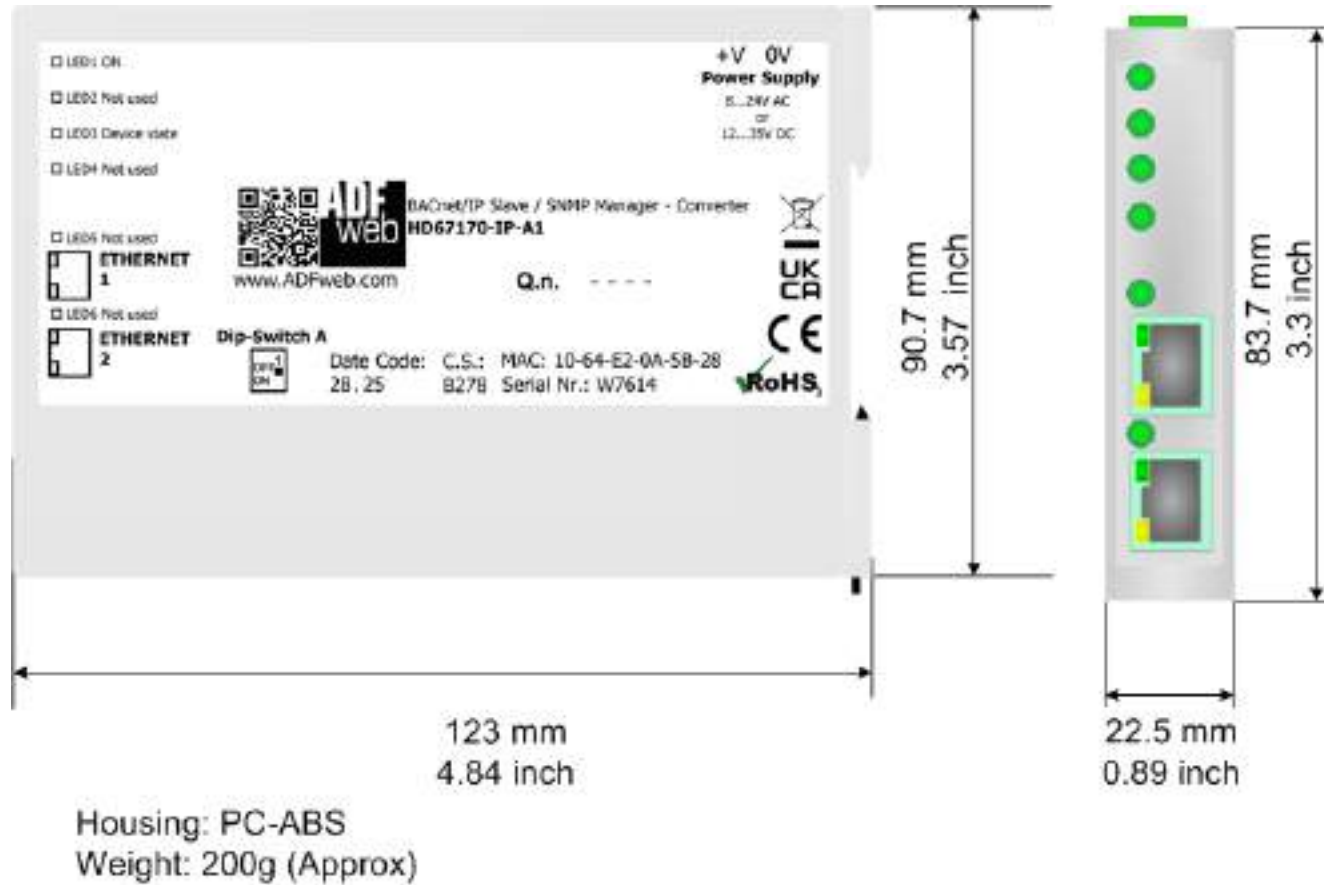

Figure 9a: Mechanical dimensions scheme for HD67170-IP-A1

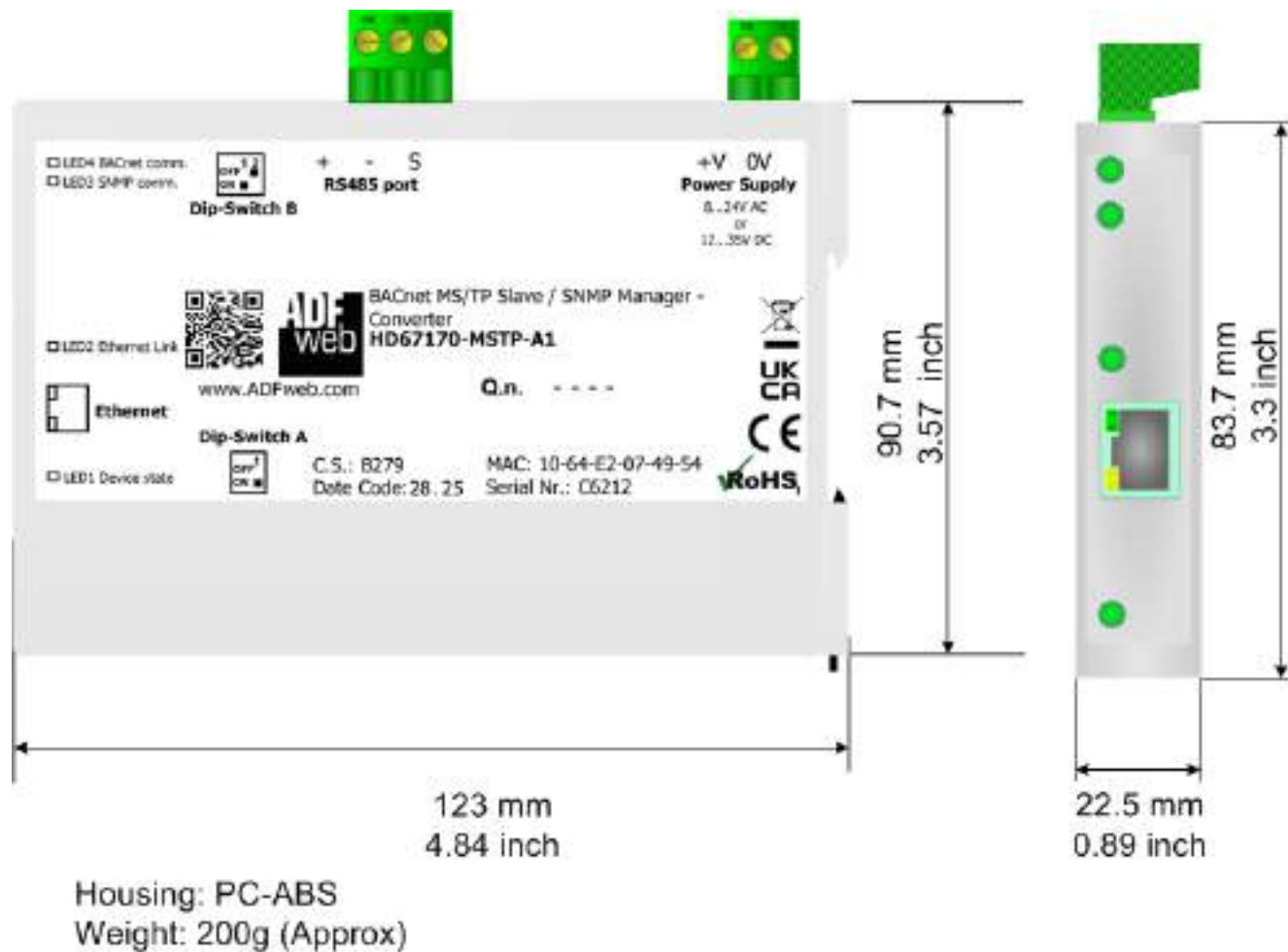

Figure 9b: Mechanical dimensions scheme for HD67170-MSTP-A1

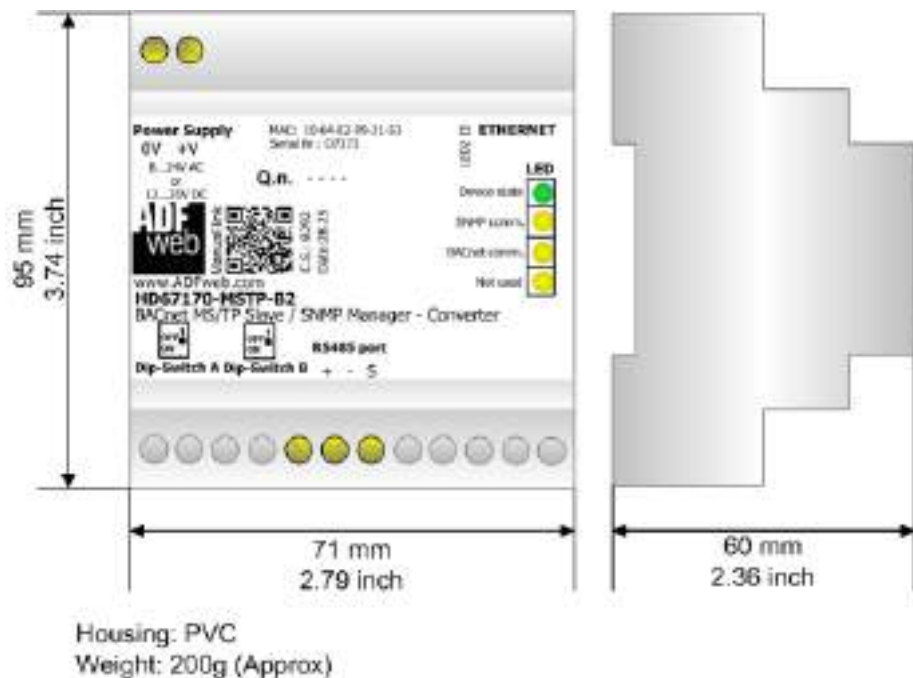
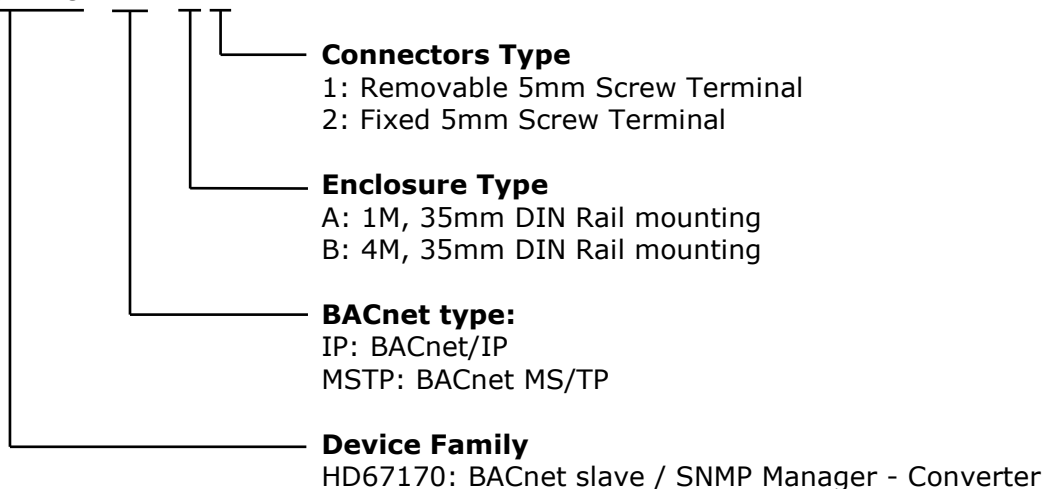

Figure 9c: Mechanical dimensions scheme for HD67170-MSTP-B2

ORDERING INFORMATIONS:

The ordering part number is formed by a valid combination of the following:

HD67170 - xx - x x



- Order Code: **HD67170-IP-A1** - BACnet/IP Slave / SNMP Manager - Converter
- Order Code: **HD67170-MSTP-A1** - BACnet MS/TP Slave / SNMP Manager - Converter
- Order Code: **HD67170-MSTP-B2** - BACnet MS/TP Slave / SNMP Manager - Converter

ACCESSORIES:

- Order Code: **AC34011** - 35mm Rail DIN - Power Supply 220/240V AC 50/60Hz – 12 V DC
- Order Code: **AC34012** - 35mm Rail DIN - Power Supply 220/240V AC 50/60Hz – 24 V DC

DISCLAIMER:

All technical content within this document can be modified without notice. The content of the document is a under continual renewal. For losses due to fire, earthquake, third party access or other accidents, or intentional or accidental abuse, misuse, or use under abnormal conditions repairs are charged to the user. ADFweb.com S.r.l. will not be liable for accidental loss of use or inability to use this product, such as loss of business income. ADFweb.com S.r.l. shall not be liable for consequences of improper use.

OTHER REGULATIONS AND STANDARDS:**WEEE INFORMATION**

Disposal of old electrical and electronic equipment (as in the European Union and other European countries with separate collection systems).

This symbol on the product or on its packaging indicates that this product may not be treated as household rubbish. Instead, it should be taken to an applicable collection point for the recycling of electrical and electronic equipment. If the product is disposed correctly, you will help prevent potential negative environmental factors and impact of human health, which could otherwise be caused by inappropriate disposal. The recycling of materials will help to conserve natural resources. For more information about recycling this product, please contact your local city office, your household waste disposal service or the shop where you purchased the product.

RESTRICTION OF HAZARDOUS SUBSTANCES DIRECTIVE

The device respects the 2002/95/EC Directive on the restriction of the use of certain hazardous substances in electrical and electronic equipment (commonly referred to as Restriction of Hazardous Substances Directive or RoHS).

CE MARKING

The product conforms with the essential requirements of the applicable EC directives.

WARRANTIES AND TECHNICAL SUPPORT:

For fast and easy technical support for your ADFweb.com SRL products, consult our internet support at www.adfweb.com.
Otherwise contact us at the address support@adfweb.com

RETURN POLICY:

If while using your product you have any problem and you wish to exchange or repair it, please do the following:

- Obtain a Product Return Number (PRN) from our internet support at www.adfweb.com. Together with the request, you need to provide detailed information about the problem.
- Send the product to the address provided with the PRN, having prepaid the shipping costs (shipment costs billed to us will not be accepted).

If the product is within the warranty of twelve months, it will be repaired or exchanged and returned within three weeks. If the product is no longer under warranty, you will receive a repair estimate.



ADFweb.com S.r.l.
Via Strada Nuova, 17
IT-31010 Mareno di Piave
TREVISO (Italy)
Phone +39.0438.30.91.31
Fax +39.0438.49.20.99
www.adfweb.com

