

User Manual

Revision 1.001
English

PROFINET / DeviceNet Master - Converter

(Order Code: HD67608-A1)

For Website information:

www.adfweb.com?Product=HD67608

For Price information:

www.adfweb.com?Price=HD67608-A1

Benefits and Main Features:

- ✦ Electrical isolation
- ✦ Two PROFINET ports
- ✦ Temperature range: -40°C / +85°C (-40°F / +185°F)



User manual

For other PROFINET products see also the following link:

Converter PROFINET to

www.adfweb.com?Product=HD67078
www.adfweb.com?Product=HD67090
www.adfweb.com?Product=HD67178
www.adfweb.com?Product=HD67600
www.adfweb.com?Product=HD67601
www.adfweb.com?Product=HD67602
www.adfweb.com?Product=HD67603
www.adfweb.com?Product=HD67604
www.adfweb.com?Product=HD67605
www.adfweb.com?Product=HD67606
www.adfweb.com?Product=HD67607
www.adfweb.com?Product=HD67609
www.adfweb.com?Product=HD67610
www.adfweb.com?Product=HD67612
www.adfweb.com?Product=HD67613
www.adfweb.com?Product=HD67614
www.adfweb.com?Product=HD67615
www.adfweb.com?Product=HD67633
www.adfweb.com?Product=HD67659
www.adfweb.com?Product=HD67660
www.adfweb.com?Product=HD67661
www.adfweb.com?Product=HD67679
www.adfweb.com?Product=HD67719
www.adfweb.com?Product=HD67752
www.adfweb.com?Product=HD67778
www.adfweb.com?Product=HD67818
www.adfweb.com?Product=HD67848
www.adfweb.com?Product=HD67876
www.adfweb.com?Product=HD67912
www.adfweb.com?Product=HD67952
www.adfweb.com?Product=HD67984
www.adfweb.com?Product=HD67B22
www.adfweb.com?Product=HD67B46
www.adfweb.com?Product=HD67C77
www.adfweb.com?Product=HD67D33
www.adfweb.com?Product=HD67E23
www.adfweb.com?Product=HD67E73
www.adfweb.com?Product=HD67F33

(M-bus)
(M-bus Wireless)
(SNMP Manager)
(NMEA 2000)
(Serial)
(Modbus Master)
(Modbus Slave)
(PROFIBUS Master)
(PROFIBUS Slave)
(CAN)
(CANopen)
(DeviceNet Slave)
(J1939)
(Modbus TCP Slave)
(SNMP Agent)
(DMX)
(NMEA 0183)
(S7comm)
(EtherNet)
(EtherNet/IP Slave)
(EtherNet/IP Master)
(BACnet Slave)
(BACnet Master)
(IEC 61850 Server)
(IEC 61850 Client)
(KNX)
(DALI)
(IO-Link Master)
(HART)
(MQTT)
(IO-Link Slave)
(OPC UA Client)
(OPC UA Server)
(EnOcean)
(LoRaWAN)
(EtherCAT Slave)
(EtherCAT Master)
(LoRaWAN Gateway)

INDEX:

	Page
INDEX	2
UPDATED DOCUMENTATION	2
REVISION LIST	2
WARNING	2
TRADEMARKS	2
SECURITY ALERT	3
EXAMPLE OF CONNECTION	4
CONNECTION SCHEME	5
CHARACTERISTICS	6
CONFIGURATION	6
POWER SUPPLY	7
FUNCTION MODES	8
LEDS	9
PROFINET	10
DEVICENET	11
USE OF COMPOSITOR SW67608	12
NEW CONFIGURATION / OPEN CONFIGURATION	13
SOFTWARE OPTIONS	14
SET COMMUNICATION	15
DEVICENET NETWORK	16
DEFINE BYTE	17
XML FILE	18
UPDATE DEVICE	19
MODBUS DIAGNOSTIC OVER PROFINET	21
MECHANICAL DIMENSIONS	22
ORDERING INFORMATIONS	23
ACCESSORIES	23
PLC CONFIGURATION	24
DISCLAIMER	27
OTHER REGULATIONS AND STANDARDS	27
WARRANTIES AND TECHNICAL SUPPORT	28
RETURN POLICY	28

UPDATED DOCUMENTATION:

Dear customer, we thank you for your attention and we remind you that you need to check that the following document is:

- Updated
- Related to the product you own

To obtain the most recently updated document, note the “document code” that appears at the top right-hand corner of each page of this document.

With this “Document Code” go to web page www.adfweb.com/download/ and search for the corresponding code on the page. Click on the proper “Document Code” and download the updates.

To obtain the updated documentation for the product that you own, note the “Document Code” (Abbreviated written "Doc. Code" on the label on the product) and download the updated from our web site www.adfweb.com/download/

REVISION LIST:

Revision	Date	Author	Chapter	Description
1.000	26/09/2012	Dp	All	First Release
1.001	07/05/2024	Ln	All	Revision

WARNING:

ADFweb.com reserves the right to change information in this manual about our product without warning.
ADFweb.com is not responsible for any error this manual may contain.

TRADEMARKS:

All trademarks mentioned in this document belong to their respective owners.

SECURITY ALERT:**GENERAL INFORMATION**

To ensure safe operation, the device must be operated according to the instructions in the manual. When using the device are required for each individual application, legal and safety regulation. The same applies also when using accessories.

INTENDED USE

Machines and systems must be designed so the faulty conditions do not lead to a dangerous situation for the operator (i.e. independent limit switches, mechanical interlocks, etc.).

QUALIFIED PERSONNEL

The device can be used only by qualified personnel, strictly in accordance with the specifications. Qualified personnel are persons who are familiar with the installation, assembly, commissioning and operation of this equipment and who have appropriate qualifications for their job.

RESIDUAL RISKS

The device is state of the art and is safe. The instrument can represent a potential hazard if they are inappropriately installed and operated by personnel untrained. These instructions refer to residual risks with the following symbol:

 This symbol indicates that non-observance of the safety instructions is danger for people to serious injury or death and / or the possibility of damage.

CE CONFORMITY

The declaration is made by us. You can send an email to support@adfweb.com or give us a call if you need it.

EXAMPLE OF CONNECTION:

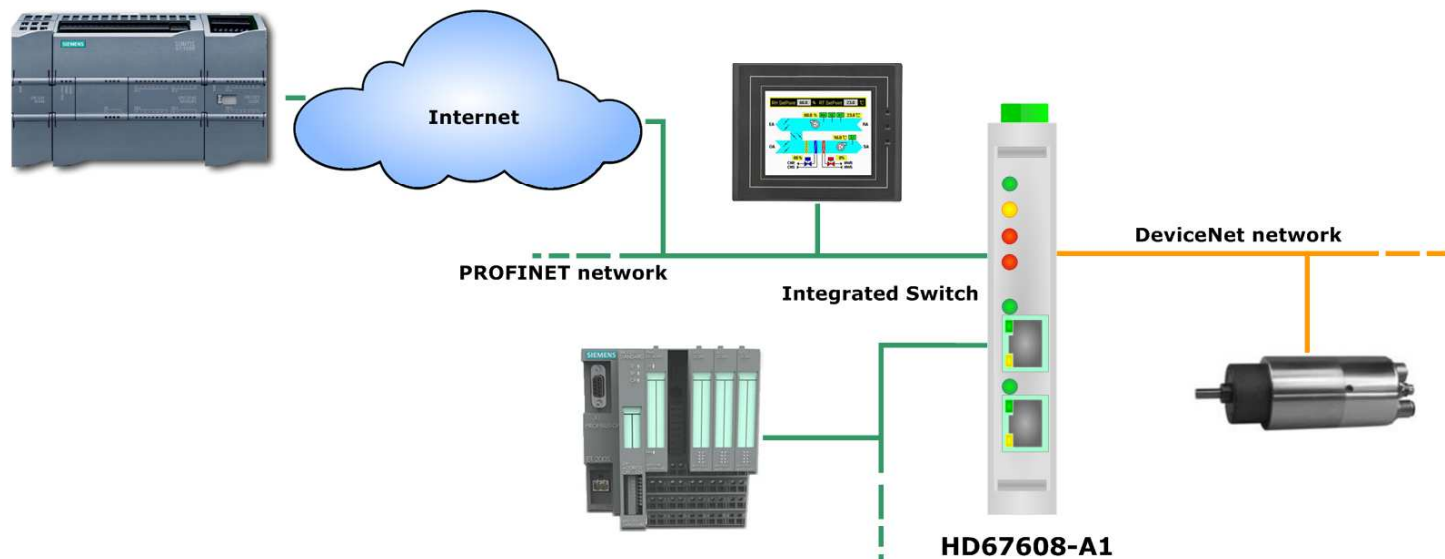
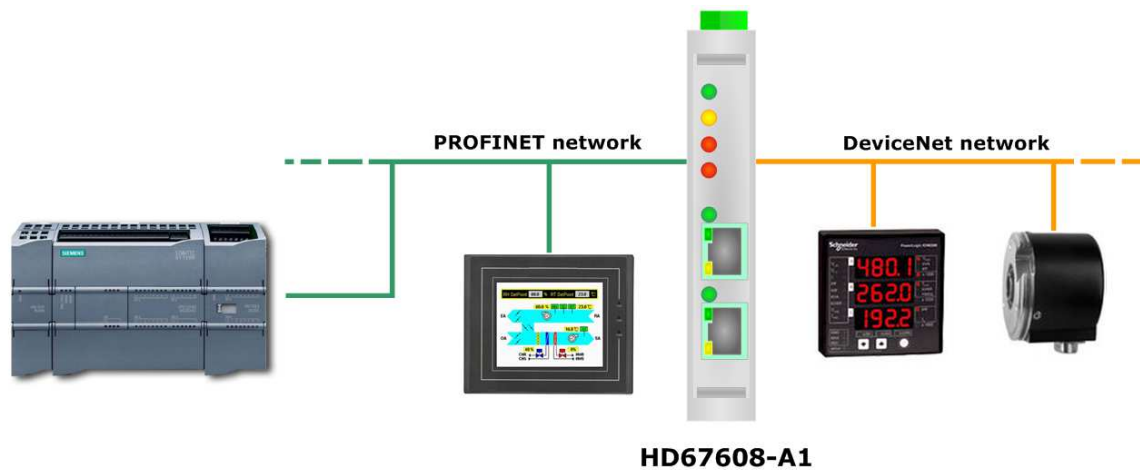

CONNECTION SCHEME:

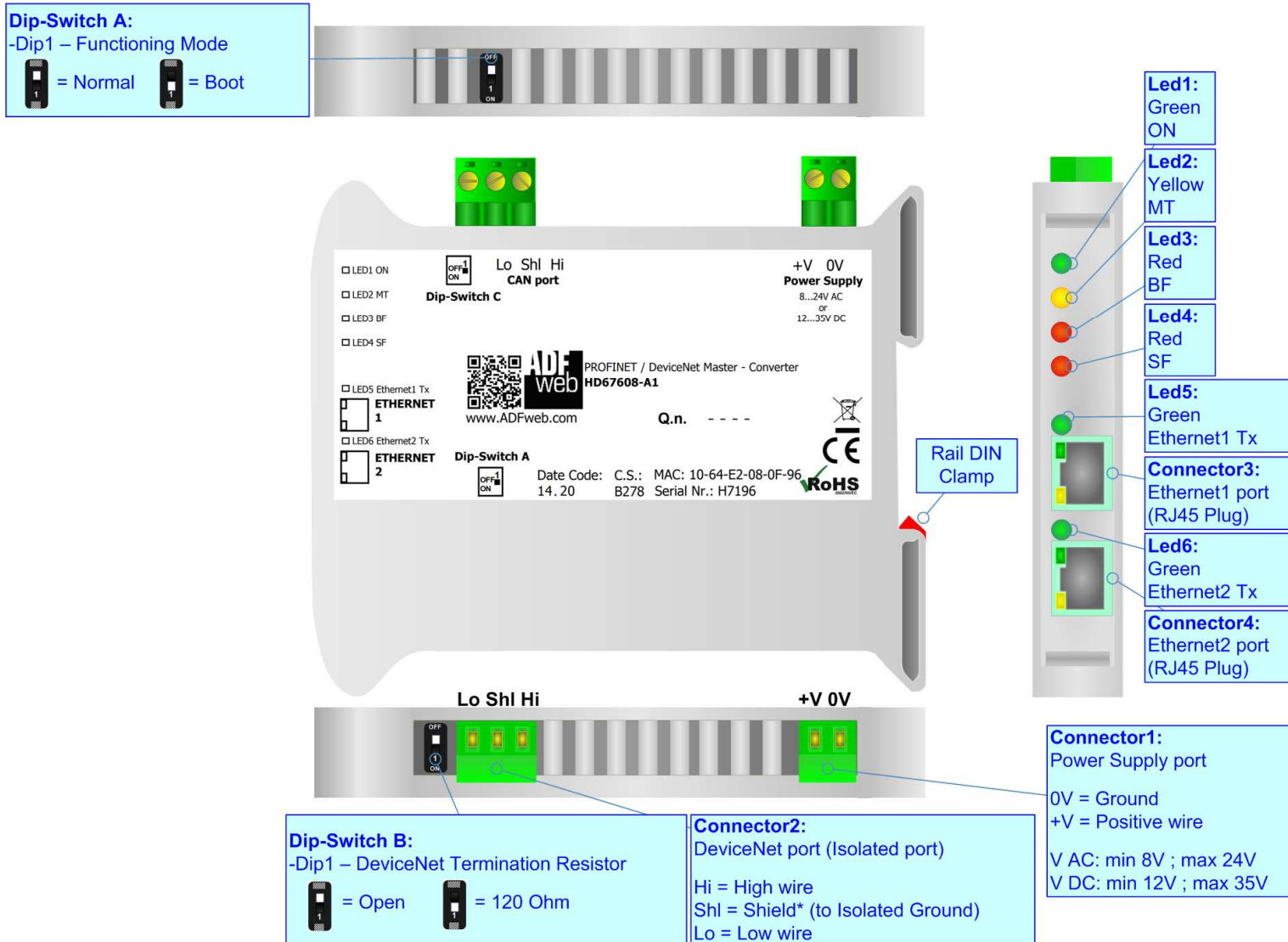

Figure 1: Connection scheme for HD67608-A1

CHARACTERISTICS:

The HD67608-A1 is a PROFINET / DeviceNet Master - Converter.

It allows the following characteristics:

- Up to 1439 bytes in reading and 1439 bytes in writing;
- Triple isolation between DeviceNet - Power Supply, DeviceNet - Ethernet, Power Supply - Ethernet.
- Two-directional information between DeviceNet bus and PROFINET bus;
- Mountable on 35mm Rail DIN;
- Wide power supply input range: 8...24V AC or 12...35V DC;
- Wide temperature range: -40°C / +85°C [-40°F / +185°F].



CONFIGURATION:

You need Compositor SW67608 software on your PC in order to perform the following:

- Define the parameter of PROFINET line;
- Define the parameter of DeviceNet line;
- Determinate which PROFINET byte transfer in DeviceNet and vice versa;
- Update the device.

POWER SUPPLY:

The devices can be powered at 8...24V AC and 12...35V DC. For more details see the two tables below.

VAC 		VDC 	
Vmin	Vmax	Vmin	Vmax
8V	24V	12V	35V

Consumption at 24V DC:

Device	Consumption [W/VA]
HD67608-A1	3.5

Connector1:
Power Supply port
0V = Ground
+V = Positive wire
V AC: min 8V ; max 24V
V DC: min 12V ; max 35V

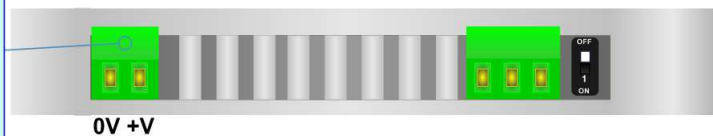

Caution: Not reverse the polarity power

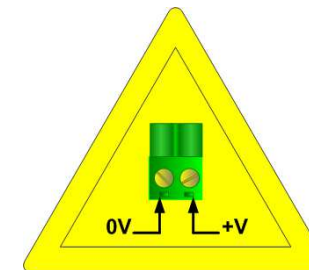

HD67608-A1

FUNCTION MODES:

The device has got two functions mode depending of the position of the Dip1 of 'Dip-Switch A':

- The first, with Dip1 in Off position (factory setting), is used for the normal working of the device.
- The second, with Dip1 in On position, is used for upload the Project/Firmware.

For the operations to follow for the updating (see 'UPDATE DEVICE' section).

According to the functioning mode, the LEDs will have specifics functions (see 'LEDS' section).

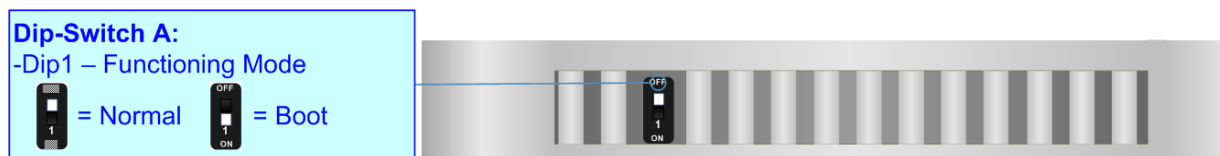

LEDS:

The device has got six LEDs that are used to give information of the functioning status. The various meanings of the LEDs are described in the table below.

LED	Normal Mode	Boot Mode
1: ON [supply voltage] (green)	ON: Device powered OFF: Device not powered	ON: Device powered OFF: Device not powered
2: MT [maintenance display] (yellow)	ON: Device not able to communicate with at least one DeviceNet Slave OFF: No maintenance are present	Blinks quickly: Boot state Blinks very slowly (~0.5Hz): update in progress
3: BF [bus fault] (red)	ON: The Ethernet connection is defective; the IP address exists several times in the network; the own NameOfStation exists several times in the network; no IP address has been set Flashing: At least one configured AR is no longer in the data exchange OFF: No errors are present	Blinks quickly: Boot state Blinks very slowly (~0.5Hz): update in progress
4: SF [group error] (red)	ON: At least one AR is not in the data exchange OFF: No errors are present	Blinks quickly: Boot state Blinks very slowly (~0.5Hz): update in progress
5: Ethernet1 Tx (green)	Blinks when is transmitting Ethernet frames	Blinks quickly: Boot state Blinks very slowly (~0.5Hz): update in progress
6: Ethernet2 Tx (green)	Blinks when is transmitting Ethernet frames	Blinks quickly: Boot state Blinks very slowly (~0.5Hz): update in progress

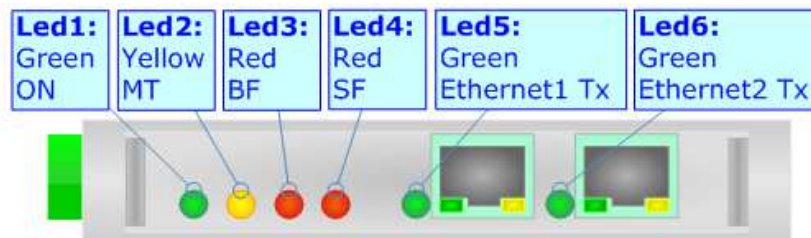

PROFINET:

The PROFINET connection must be made using Connector3 and/or Connector4 of HD67608-A1 with at least a Category 5E cable. The maximum length of the cable should not exceed 100m. The cable has to conform to the T568 norms relative to connections in cat.5 up to 100 Mbps. To connect the device to an Hub/Switch is recommended the use of a straight cable, to connect the device to a PC/PLC/other is recommended the use of a cross cable.

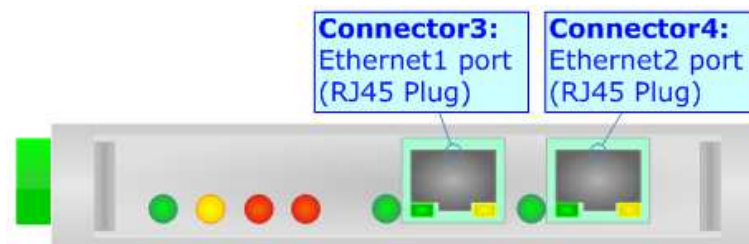

DeviceNet:

For terminate the DeviceNet line with a 120Ω resistor it is necessary that the Dip1 of 'Dip-Switch A' is at ON position.

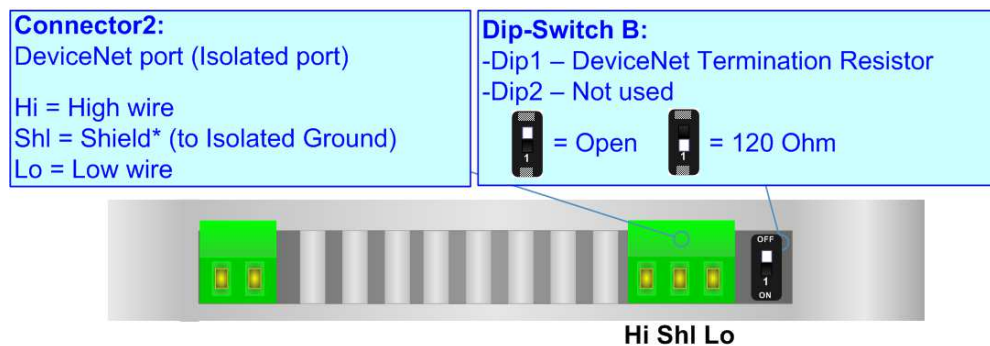

Cable characteristics:

DC parameter:	Impedance	70 Ohm/m
AC parameters:	Impedance	120 Ohm/m
	Delay	5 ns/m
Length	Baud Rate [bps]	Length MAX [m]
	125 K	500
	250 K	250
	500 K	100

USE OF COMPOSITOR SW67608:

To configure the Converter, use the available software that runs with Windows called SW67608. It is downloadable on the site www.adfweb.com and its operation is described in this document. *(This manual is referenced to the last version of the software present on our web site)*. The software works with MSWindows (XP, Vista, Seven, 8, 10 or 11; 32/64bit).

When launching the SW67608, the window below appears (Fig. 2).



Note:

It is necessary to have installed .Net Framework 4.

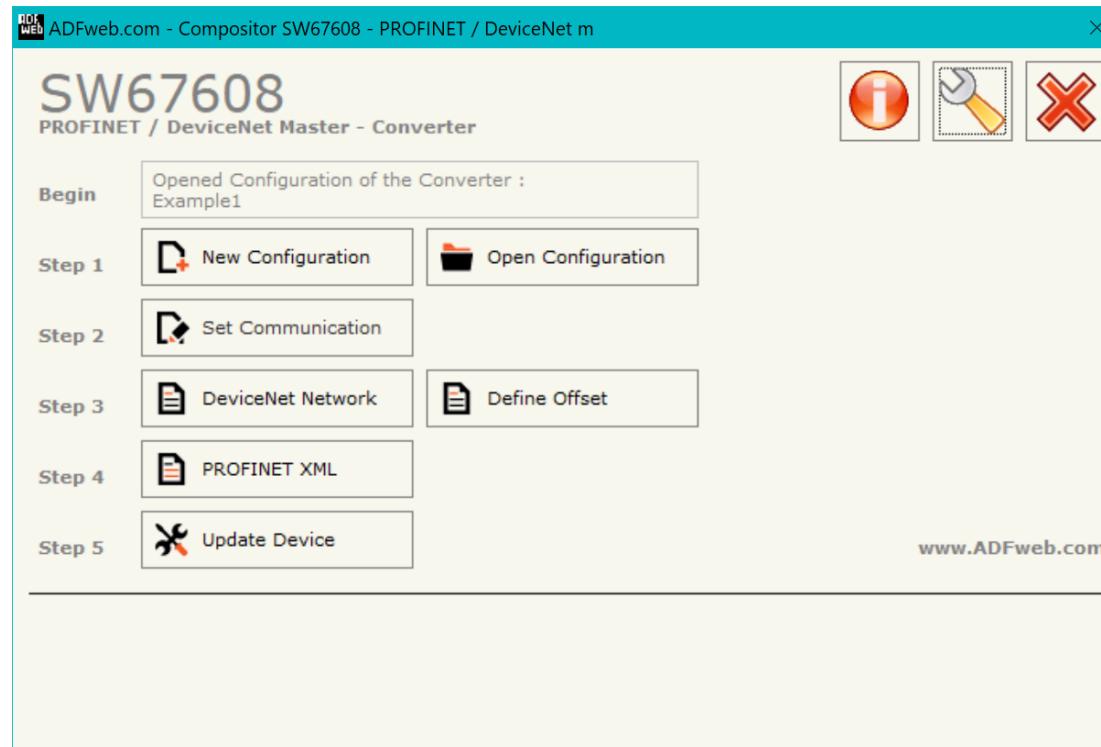
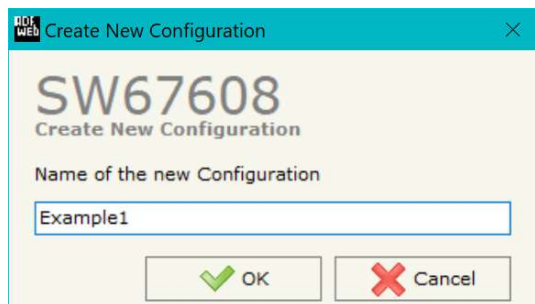

Figure 2: Main window for SW67608

NEW CONFIGURATION / OPEN CONFIGURATION:

The “**New Configuration**” button creates the folder which contains the entire device’s configuration.



A device’s configuration can also be imported or exported:

- To clone the configurations of a Programmable “PROFINET / DeviceNet Master - Converter” in order to configure another device in the same manner, it is necessary to maintain the folder and all its contents;
- To clone a project in order to obtain a different version of the project, it is sufficient to duplicate the project folder with another name and open the new folder with the button “**Open Configuration**”.

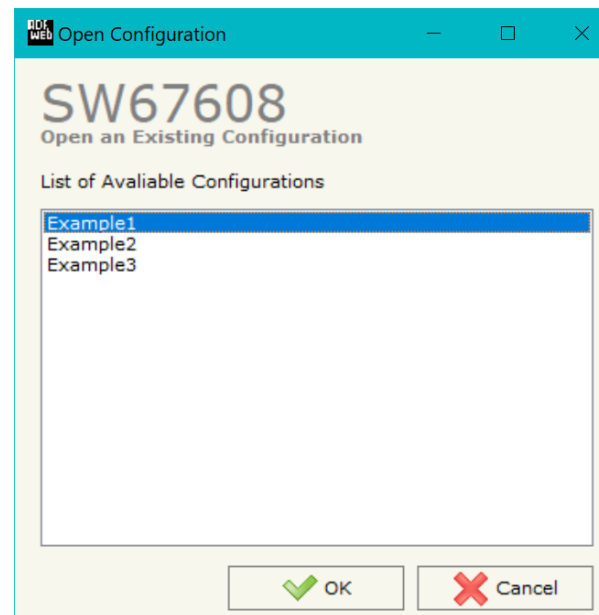

SOFTWARE OPTIONS:

By pressing the “**Settings**” () button there is the possibility to change the language of the software and check the updatings for the compositor.

In the section “Language” it is possible to change the language of the software.

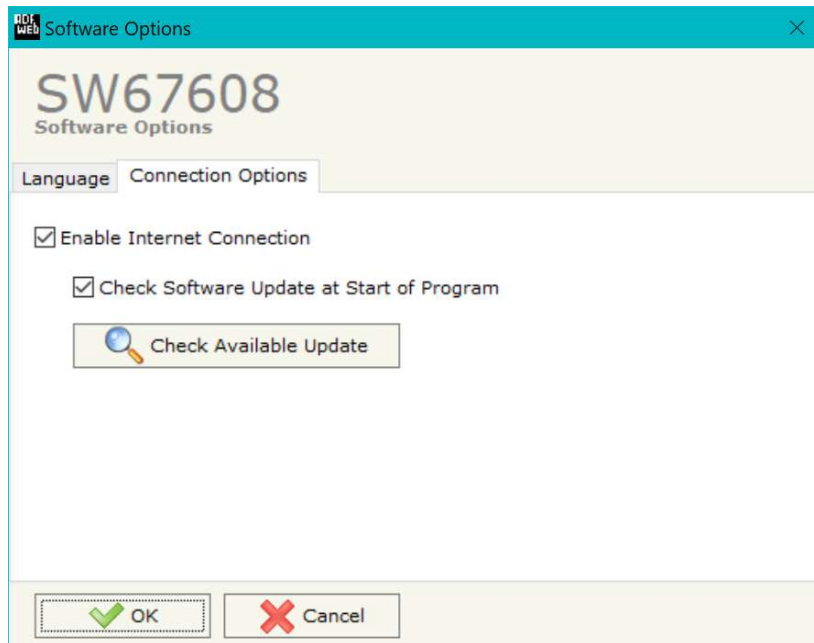

In the section “Connection Options”, it is possible to check if there are some updatings of the software compositor in ADFweb.com website. Checking the option “**Check Software Update at Start of Program**”, the SW67608 check automatically if there are updatings when it is launched.

SET COMMUNICATION:

This section define the fundamental communication parameters of two buses, PROFINET and DeviceNet Master.

By Pressing the **"Set Communication"** button from the main window for SW67608 (Fig. 2) the window "Set Communication" appears (Fig. 3).

The window is divided in two sections, one for the PROFINET and the other for the DeviceNet Master.

The means of the fields for "PROFINET" are:

- In the fields **"IP ADDRESS"** insert the IP address that you want to give to the Converter;
- In the fields **"SUBNET Mask"** insert the SubNet Mask;
- In the fields **"GATEWAY"** insert the default gateway that you want to use. This feature can be enabled or disabled pressing the Check Box field. This feature is used for going out of the net;
- In the field **"Port"** the port used for PROFINET communication is defined. The port has a fixed value of 34964;
- In the field **"PROFINET Name of Station"** is possible to assign a name to the PROFINET node;
- In the field **"PROFINET → Gateway"** insert the number of input byte of the slave station;
- In the field **"PROFINET ← Gateway"** insert the number of output byte of the slave station;
- In the field **"Diagnostic"** insert the starting byte of the PROFINET array where you will save the diagnostic of DeviceNet. It is possible to enable/disable this function using the checkbox. For more informations about the diagnostic, see "Diagnostic" section on page 21.

The means of the fields for the "DeviceNet Master" section are:

- In the field **"ID Device"** the address for the DeviceNet Master is defined;
- In the field **"Baudrate"** the velocity of the DeviceNet Master bus is defined.

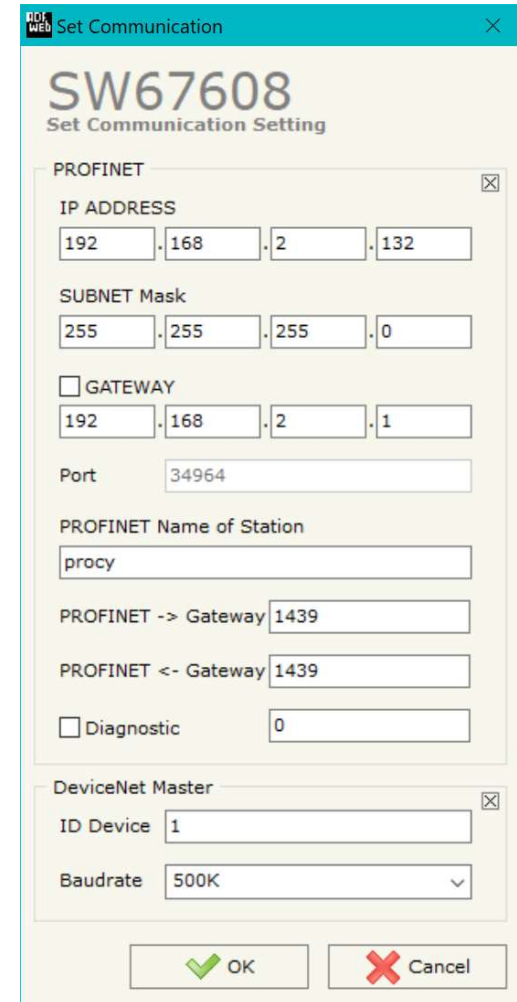

Figure 3: "Set Communication" window

DEVICENET NETWORK:

By pressing the “**DeviceNet Network**” button from the main window for SW67608 (Fig. 2) the window “DeviceNet Network” appears (Fig. 4).

The data of the columns have the following meanings:

- In the field “**ID**” the ID of a slave DeviceNet device is defined;
- In the field “**N BYTE IN**” the number of input byte of the slave DeviceNet is defined;
- In the field “**N BYTE OUT**” the number of output byte of the slave DeviceNet is defined;
- If the field “**Reset on DeviceNet**” is checked, the data are reset to 0 if PROFINET side is in error;
- If the field “**Reset on PROFINET**” is checked, the data are reset to 0 if DeviceNet side is in error;
- In the field “**Mnemonic**” is possible to insert a description. It isn’t necessary compiling this field, is only a label.

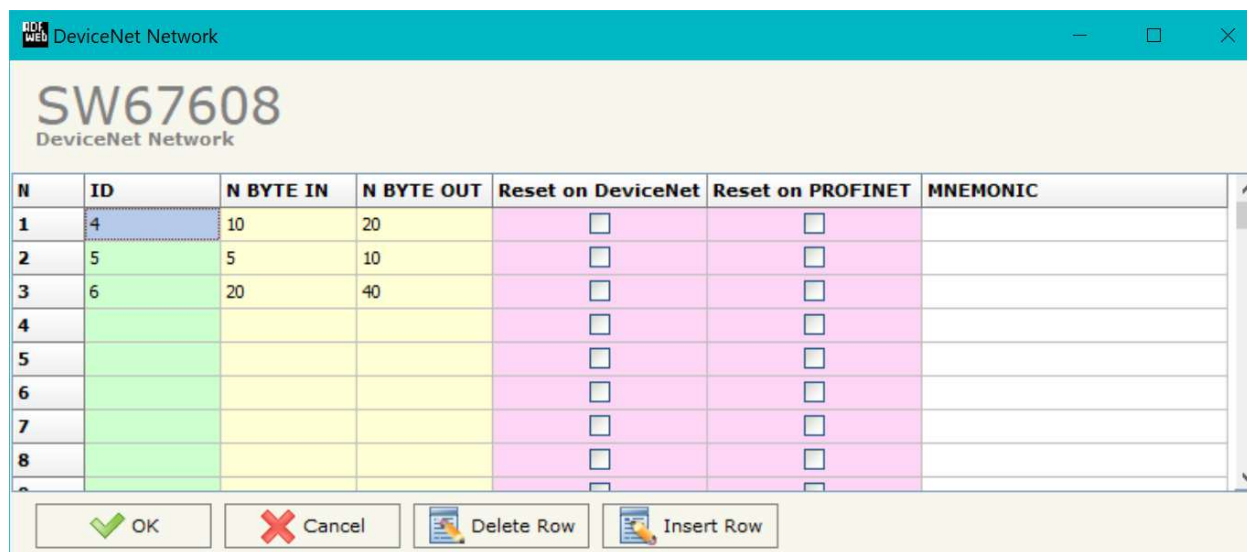

Figure 4: “DeviceNet Network” window

DEFINE BYTE:

By pressing the "Define Byte" button from the main window for SW67608 (Fig. 2) the window "Define Offset" appears (Fig. 5).

In the field "Select the Slave DeviceNet" it is possible to select the slave to configure between those defined in the "DeviceNet Network" step.

The data of the column have the following meanings:

Byte IN side:

- In the column "Offset" it is possible to select the desired byte of DeviceNet which will be written from the PROFINET Master;
- In the column "Mnemonic" is possible to insert a description. It isn't necessary compiling this field, is only a label.

Byte OUT side:

- In the column "Offset" it is possible to select the desired byte of DeviceNet which will be read from the PROFINET Master;
- In the column "Mnemonic" is possible to insert a description. It isn't necessary compiling this field, is only a label.

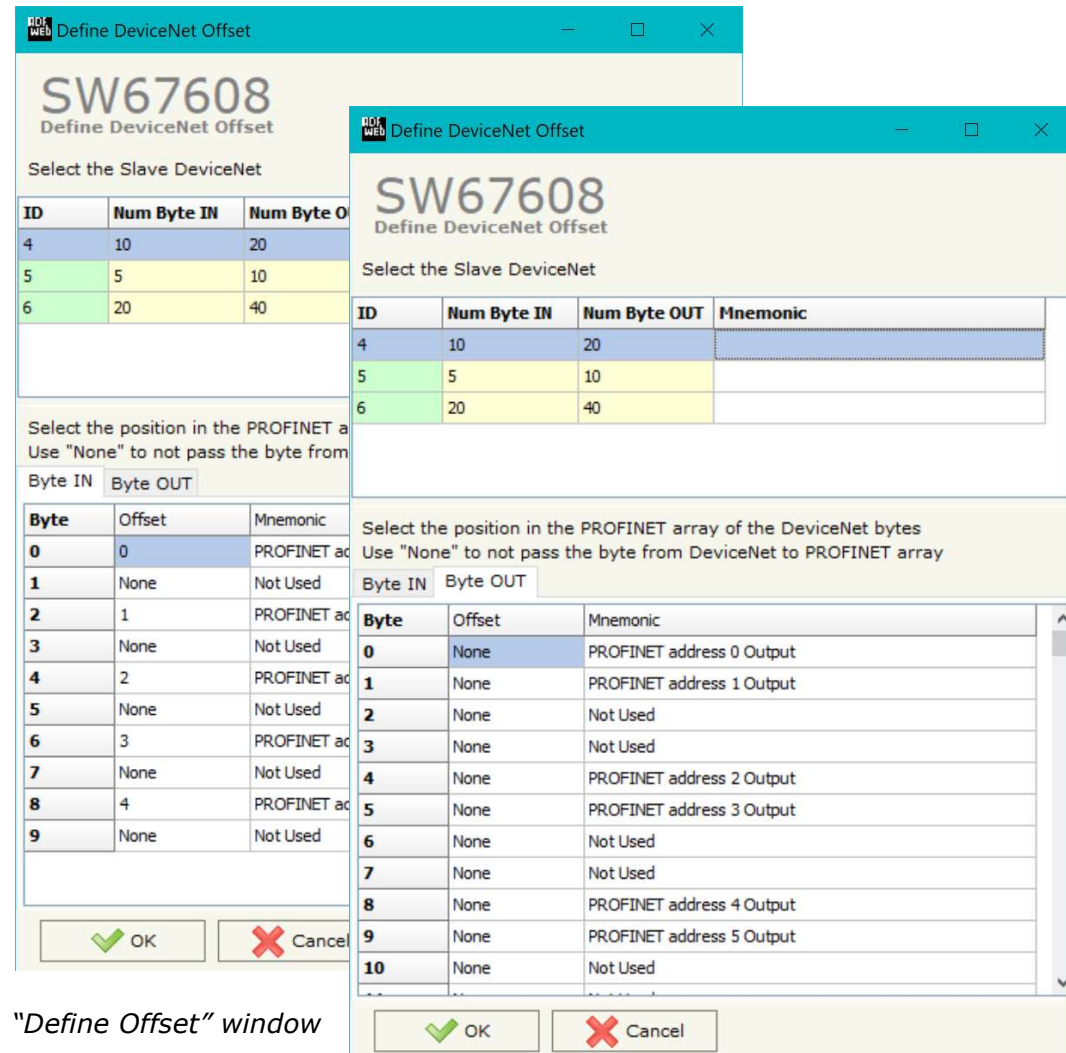

Figure 5: "Define Offset" window

XML FILE:

By Pressing the "**PROFINET XML**" button from the main window for SW67608 (Fig. 2) it is possible to generate the xml file to be imported into the master PROFINET.

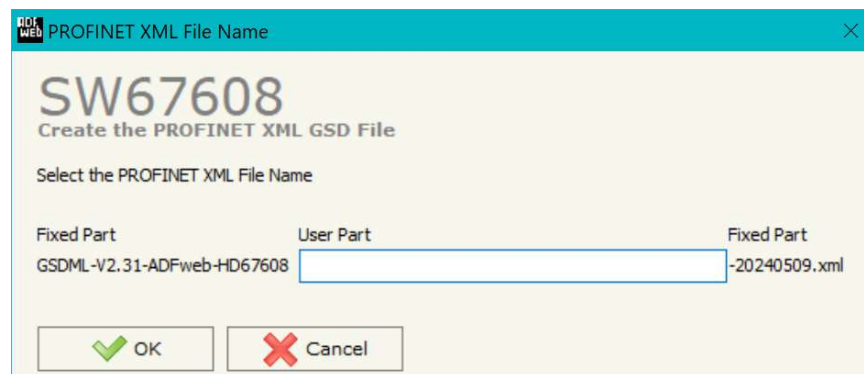

Figure 5: "PROFINET XML File Name" window

UPDATE DEVICE:

By pressing the **“Update Device”** button, it is possible to load the created Configuration into the device; and also the Firmware, if necessary. This by using the Ethernet port.

If you don't know the actual IP address of the device you have to use this procedure:

- Turn OFF the Device;
- Put Dip1 of 'Dip-Switch A' in ON position;
- Turn ON the device
- Connect the Ethernet cable;
- Insert the IP **“192.168.2.205”**;
- Select which operations you want to do;
- Press the **“Execute update firmware”** button to start the upload;
- When all the operations are “OK” turn OFF the Device;
- Put Dip1 of 'Dip-Switch A' in OFF position;
- Turn ON the device.

If you know the actual IP address of the device, you have to use this procedure:

- Turn ON the Device with the Ethernet cable inserted;
- Insert the actual IP of the Converter;
- Select which operations you want to do;
- Press the **“Execute update firmware”** button to start the upload;
- When all the operations are “OK” the device automatically goes at Normal Mode.

At this point the configuration/firmware on the device is correctly updated.



Figure 6: "Update device" windows

**Note:**

When you receive the device, for the first time, you also have to update the Firmware in the HD67608 device.

**Warning:**

If Fig. 7 appears when you try to do the Update try these points before seeking assistance:

- ➔ Try to repeat the operations for the updating;
- ➔ Try with another PC;
- ➔ Try to restart the PC;
- ➔ Check the LAN settings;
- ➔ If you are using the program inside a Virtual Machine, try to use in the main Operating System;
- ➔ If you are using Windows Seven, Vista, 8, 10 or 11 make sure that you have the administrator privileges;
- ➔ In case you have to program more than one device, using the "UDP Update", you have to cancel the ARP table every time you connect a new device on Ethernet. For do this you have to launch the "Command Prompt" and write the command "arp -d". Pay attention that with Windows Vista, Seven, 8, 10 or 11 you have to launch the "Command Prompt" with Administrator Rights;
- ➔ Pay attention at Firewall lock.

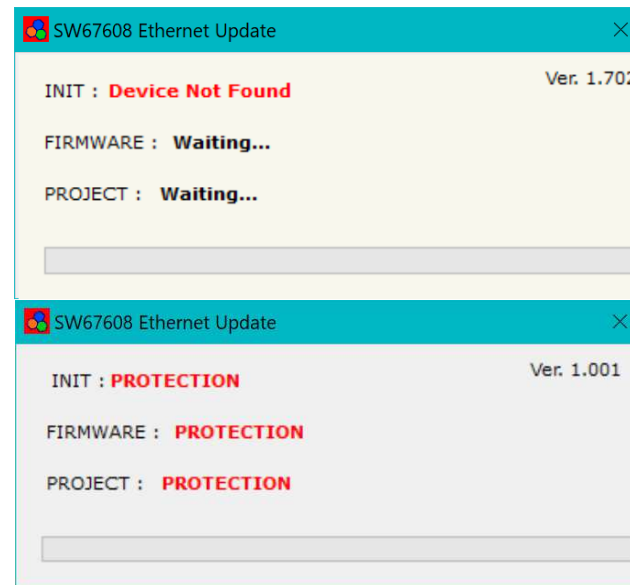

Figure 7: "Error" window

**Warning:**

In the case of HD67608 you have to use the software "SW67608": www.adfweb.com/download/filefold/SW67608.zip.

MODBUS DIAGNOSTIC OVER PROFINET:

During the normal functioning of the device, if all configured DeviceNet slaves are communicating, every PROFINET frame has the "Data Status" byte at the value of 0x35.

Otherwise, the "Data Status" byte assumes the value 0x15; that means "Problem Indicator".

It is possible to save the Modbus Diagnostic on Output PROFINET array using the field "Diagnostic" of the section "Set Communication".

In this case, the status of each DeviceNet slave in the section "DeviceNet Network" is saved starting from the byte of the PROFINET array defined in the section "Set Communication".

Each bit will represent the status of a Modbus request:

- If the communication with the DeviceNet slave is good, the status bit is put to '1';
- If the communication with the DeviceNet slave is in error or timeout, the status bit is put to '0'.

MECHANICAL DIMENSIONS:

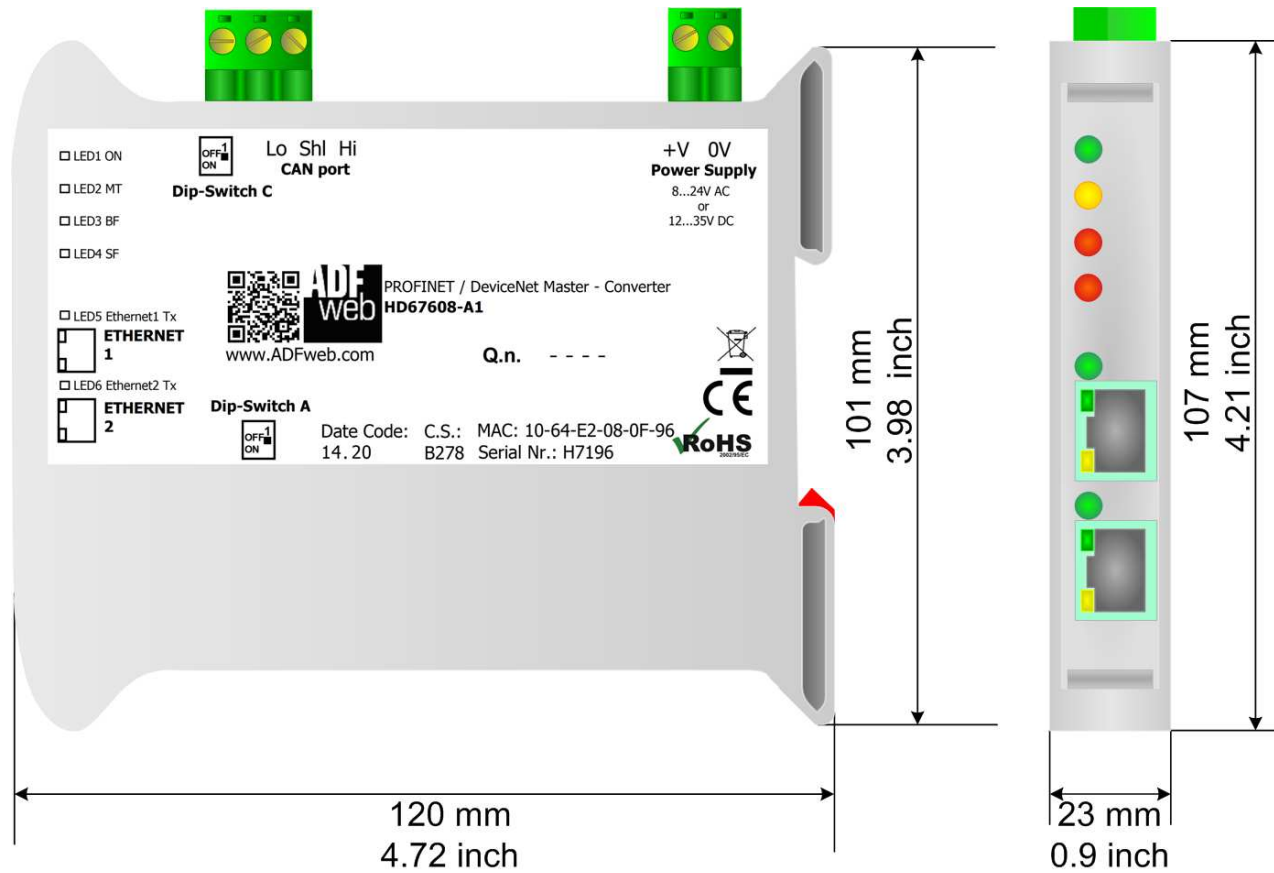

Housing: PVC
Weight: 200g (Approx)

Figure 8: Mechanical dimensions scheme for HD67608-A1

ORDERING INFORMATIONS:

The ordering part number is formed by a valid combination of the following:

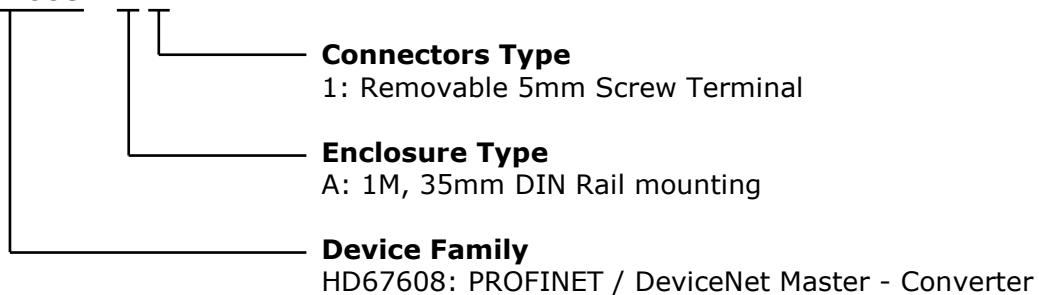
HD67608 - A 1

Order Code: **HD67608-A1** - PROFINET / DeviceNet Master - Converter

ACCESSORIES:

Order Code: **AC34011** - 35mm Rail DIN - Power Supply 220/240V AC 50/60Hz – 12 V DC

Order Code: **AC34012** - 35mm Rail DIN - Power Supply 220/240V AC 50/60Hz – 24 V DC

PLC CONFIGURATION:

The configuration and commissioning of the PROFINET Converter as described on the following pages was accomplished with the help of the TIA Portal V11-software of Siemens. In case of using a control system from another supplier please attend to the associated documentation. These are the steps to follow:

- 1) Install the description file of the module.

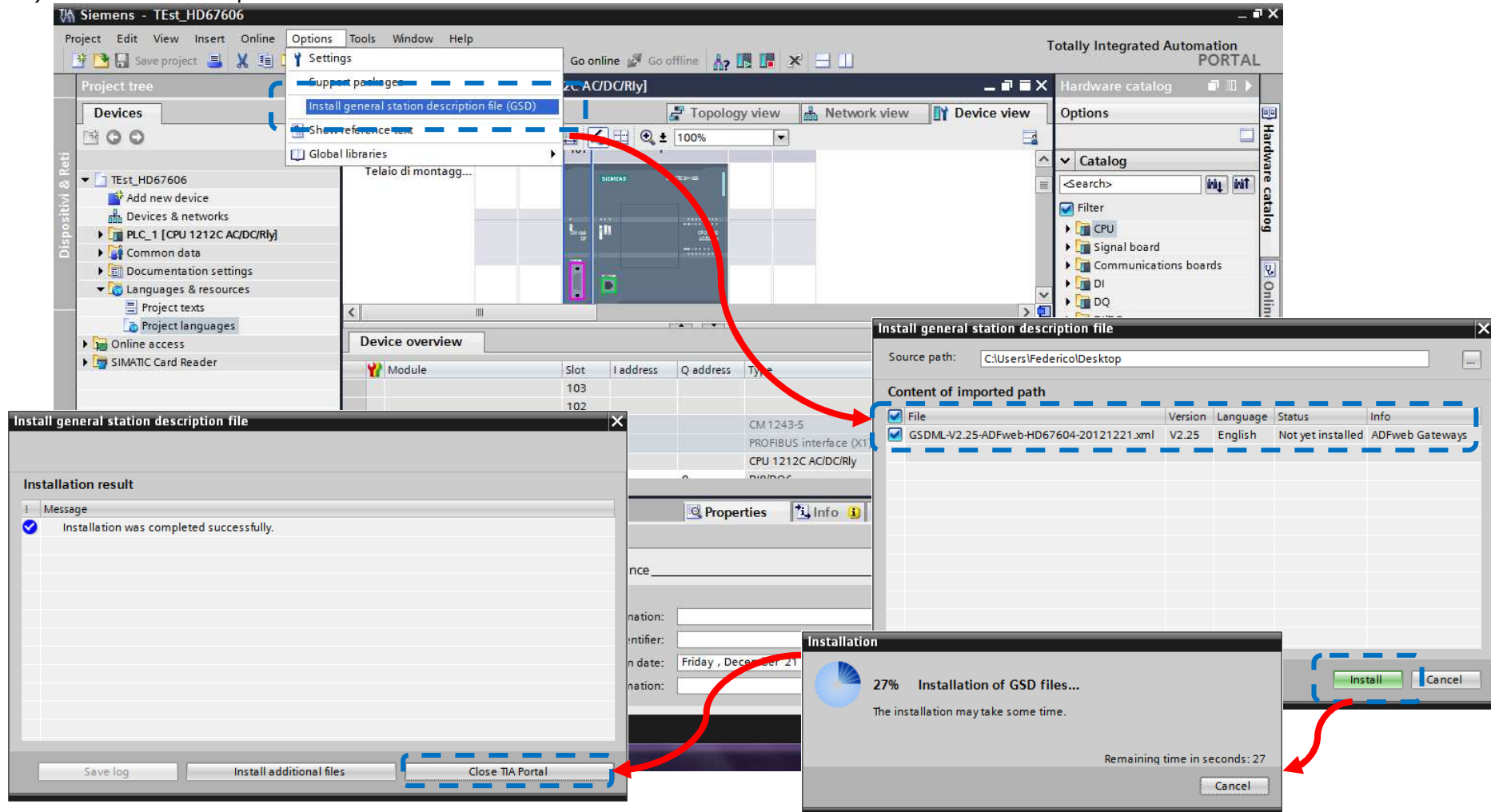

2) Import the module in the network; connect the device to the PLC network and edit the parameters of IP, station name etc.

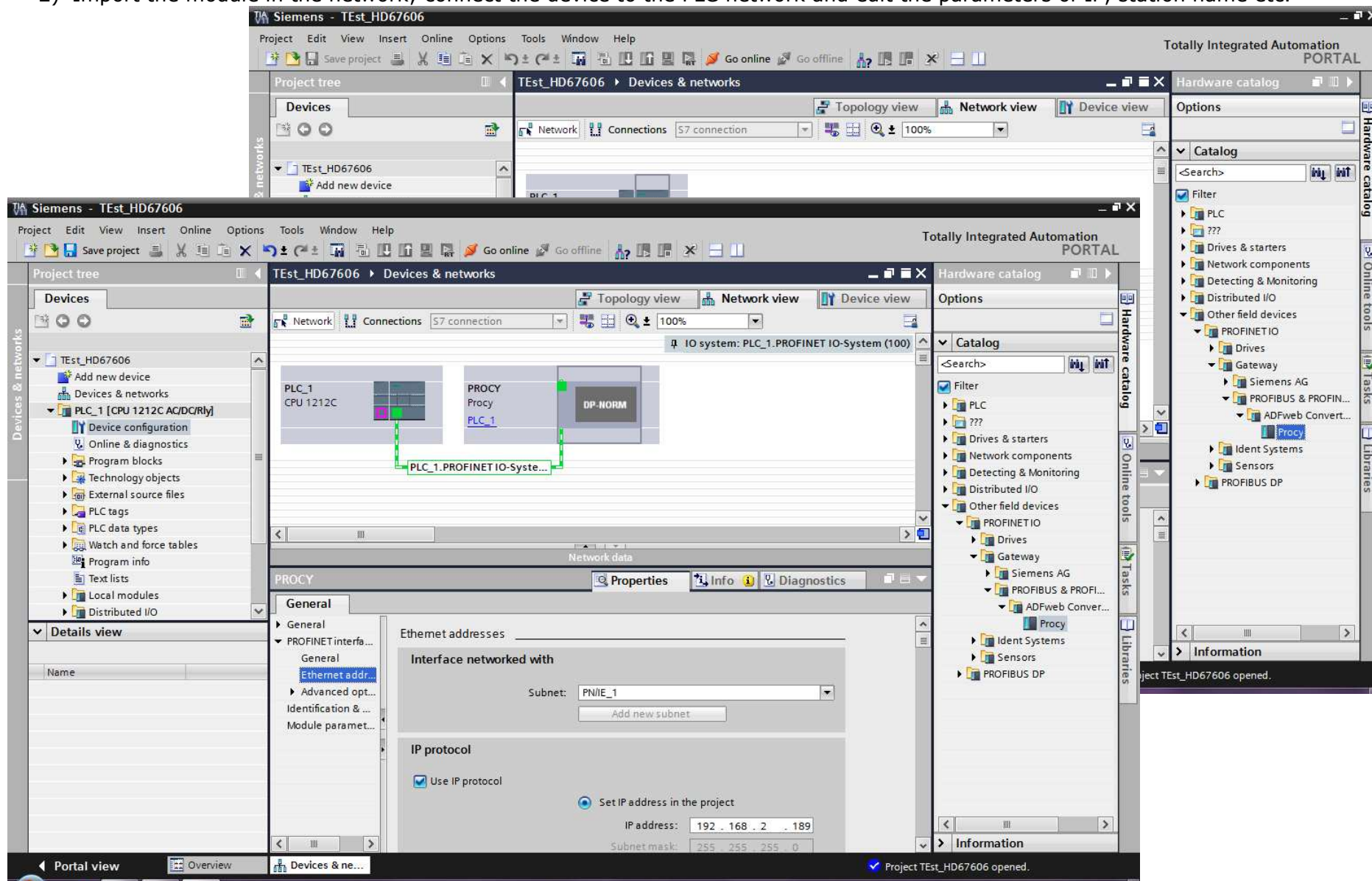

3) Load the configuration into the PLC.

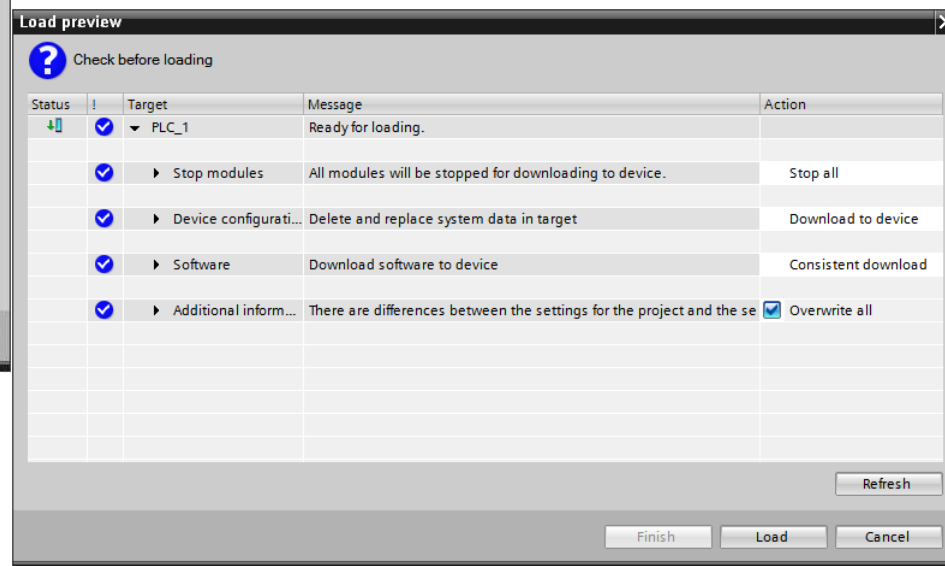
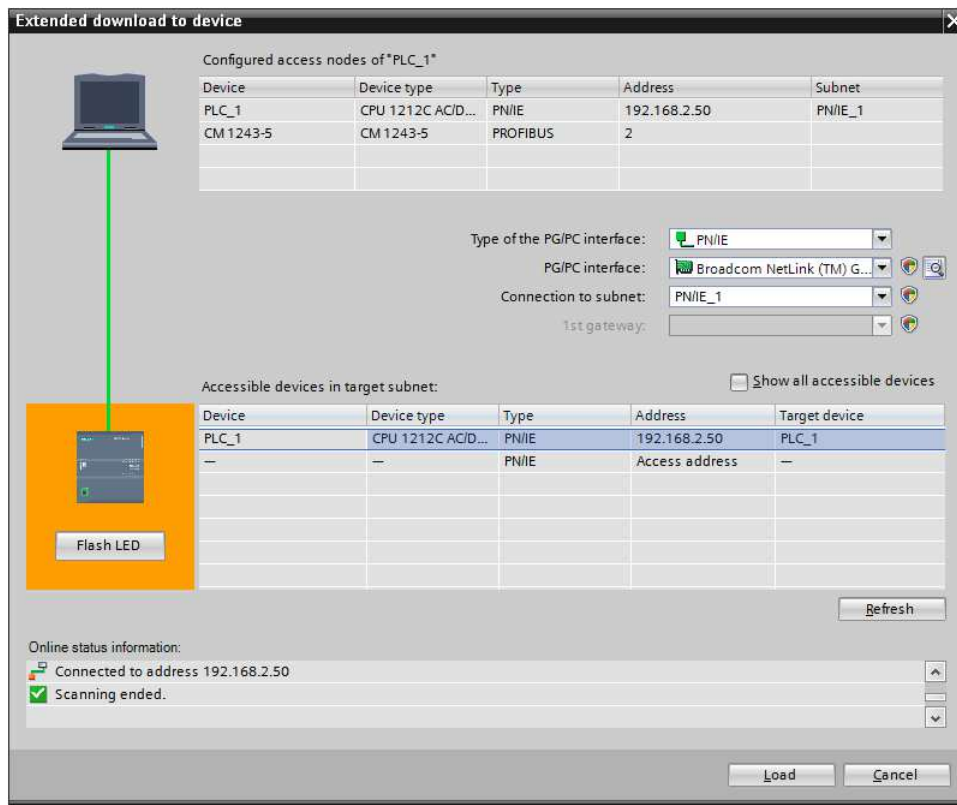

DISCLAIMER

All technical content within this document can be modified without notice. The content of the document content is a recurring audit. For losses due to fire, earthquake, third party access or other accidents, or intentional or accidental abuse, misuse, or use under abnormal conditions repairs are charged to the user. ADFweb.com S.r.l. will not be liable for accidental loss of use or inability to use this product, such as loss of business income. ADFweb.com S.r.l. shall not be liable for consequences of improper use.

OTHER REGULATIONS AND STANDARDS

WEEE INFORMATION



Disposal of old electrical and electronic equipment (as in the European Union and other European countries with separate collection systems).

— This symbol on the product or on its packaging indicates that this product may not be treated as household rubbish. Instead, it should be taken to an applicable collection point for the recycling of electrical and electronic equipment. If the product is disposed correctly, you will help prevent potential negative environmental factors and human health, which could otherwise be caused by inappropriate disposal. The recycling of materials will help to conserve natural resources. For more information about recycling this product, please contact your local city office, your household waste disposal service or the shop where you purchased the product.

RESTRICTION OF HAZARDOUS SUBSTANCES DIRECTIVE



The device respects the 2002/95/EC Directive on the restriction of the use of certain hazardous substances in electrical and electronic equipment (commonly referred to as Restriction of Hazardous Substances Directive or RoHS).

CE MARKING



The product conforms with the essential requirements of the applicable EC directives.

WARRANTIES AND TECHNICAL SUPPORT:

For fast and easy technical support for your ADFweb.com SRL products, consult our internet support at www.adfweb.com.
Otherwise contact us at the address support@adfweb.com

RETURN POLICY:

If while using your product you have any problem and you wish to exchange or repair it, please do the following:

- 1) Obtain a Product Return Number (PRN) from our internet support at www.adfweb.com. Together with the request, you need to provide detailed information about the problem.
- 2) Send the product to the address provided with the PRN, having prepaid the shipping costs (shipment costs billed to us will not be accepted).

If the product is within the warranty of twelve months, it will be repaired or exchanged and returned within three weeks. If the product is no longer under warranty, you will receive a repair estimate.



ADFweb.com S.r.l.
Via Strada Nuova, 17
IT-31010 Mareno di Piave
TREVISO (Italy)
Phone +39.0438.30.91.31
Fax +39.0438.49.20.99
www.adfweb.com

